

Multi-active Façades for Renovation of Million Program Houses

**An Analysis from Energy and Life Cycle Cost
Perspectives**

Linn Adolfsson & Charlotte Andersson

Master's thesis in Energy-efficient and Environmental
Buildings Faculty of Engineering | Lund University



Lund University

Lund University, with eight faculties and a number of research centres and specialized institutes, is the largest establishment for research and higher education in Scandinavia. The main part of the University is situated in the small city of Lund which has about 112 000 inhabitants. A number of departments for research and education are, however, located in Malmö. Lund University was founded in 1666 and has today a total staff of 6 000 employees and 47 000 students attending 280 degree programmes and 2 300 subject courses offered by 63 departments.

Master Programme in Energy-efficient and Environmental Building Design

This international programme provides knowledge, skills and competencies within the area of energy-efficient and environmental building design in cold climates. The goal is to train highly skilled professionals, who will significantly contribute to and influence the design, building or renovation of energy-efficient buildings, taking into consideration the architecture and environment, the inhabitants' behaviour and needs, their health and comfort as well as the overall economy.

The degree project is the final part of the master programme leading to a Master of Science (120 credits) in Energy-efficient and Environmental Buildings.

Keywords: million program house, multi-active façade, traditional renovation measures, LCC analysis, energy calculations.

Thesis: EEBD - June / 2016

Abstract

Sweden faces an upcoming period where thousands of buildings built during the million program period will be in need of a façade renovation. There is a large energy-saving potential in these buildings, since they are often poorly insulated and often have a ventilation system without heat recovery. Performing energy-efficient renovation measures to a building are expensive, which results in that the property owner does not undergo the renovation. This in return can lead to that the façades of the million program houses deteriorate.

The aim of this master's thesis was to map developed multi-active façade systems on the market, to determine if integrating multi-active façade systems to million program houses is a more energy and cost efficient solution compared to integrating traditional renovation measures separately.

In order to accomplish this, a thorough market review was performed to determine the quantity of multi-active façades in Europe. Two prefabricated multi-active façade systems and one that is mounted on site were chosen to perform a deeper investigation of their energy performance and Life Cycle Cost. The analyses were performed by integrating the multi-active façade systems to a typical million program house located in Landskrona, which was used as a reference house. The condition of the façades of the reference house was better than expected, which means they are not in an immediate need of renovation. The multi-active façade systems were compared to both traditional renovation measures and the current status of the reference house.

The multi-active façade systems reduced the energy use of the reference house as much as the traditional renovation measures. The total energy use was reduced by approximately 60 % and the heating demand by approximately 80 %. The most energy-efficient renovation measure to integrate was the balanced ventilation system with heat recovery, which also improved the indoor climate in the apartments. The energy-efficient measures did not, however, pay themselves off in the form of reduced energy use and thus lower running costs. This master thesis found that neither integrating multi-active facade systems nor mounting traditional renovation measures are directly profitable. Profitability can only be achieved when there is a need to renovate the façade and the costs can be covered by the maintenance cost, and not as an energy measure. One of the multi-active façade systems did, however, have the same cost over a 40 year period as traditional renovation measures. If the property owner could raise the rent with 316 – 699 SEK/month, all the renovation solutions would be profitable to carry though. The advantages of installing a multi-active façade system contribute to low disturbance for the tenants because of only few visits inside the apartments. Also, the construction time becomes shorter on site and the tenants do not need any compensation.

Preface

We would like to thank our supervisors Åke Blomsterberg at LTH/WSP and Emma Karlsson at WSP, for their guidance and support during our master's thesis writing. We would also like to thank the division of Byggnadsfysik at WSP Malmö for their welcome and kindness during our work at the division this half year. Thanks to Jens Åkesson at WSP, for his knowledge and support with the energy calculations.

Thanks to Stefan Forsberg at Smartfront for meeting with us, sharing information and knowledge and for answering all our questions along the road.

We also would like to thank Frank Lattke, project coordinator for SmartTES and Daniel Bouteiller-Marin, Engineer at GAP³ Solutions, for sharing information about the façade systems and for answering our questions.

Thanks to Wikells byggberäkningar AB for letting us attend the one day course to learn Sektionsdata. Especially thanks to Johan Fromell for teaching and supporting us.

Thanks to Johan Zellbi at Landskronahem for answering all our questions and for letting us perform this study on one of Landskronahem's buildings.

We would also like to thank Tomas Ekström at NCC for introducing IDA ICE and for answering questions.

Big thanks to all the companies and research projects for their permission to publish photos of their façade systems and pilot projects. The published pictures are borrowed from GAP³ Solutions, TES Energyfaçade, Smartfront, SAPA Building System, Adaptiwall, MeeFS and Skanska.

At last we would like to thank our families and friends for supporting us during this period. But most of all we would like to thank each other for these last months of hard work. Lots of laughter, tea and great teamwork made this master's thesis.

Table of contents

Abstract	3
Preface	4
Table of contents	5
1 Introduction	7
1.1 Background	7
1.2 Aim and Objectives	9
1.3 Scope	9
1.4 Overall approach	10
1.5 Limitations	12
1.6 Terminologies	12
1.7 Contributions	13
2 Literature study	14
2.1 Swedish building regulation	14
2.1.1 Energy regulations	14
2.1.2 Maintenance or reconstruction of the building	14
2.1.3 Municipal housing companies	15
2.1.4 Tenants' right during renovation	16
2.2 The Swedish Energy Agency financed network BeBo	17
2.3 Nordic Built	17
2.4 Multi-active façade definition	18
3 Market review and reference projects	19
3.1 Façade system 1 – GAP ³ Solutions	19
3.1.1 Reference project – Renovation of Graz, Dieselweg	23
3.1.2 Reference project – Renovation of Linz, Makartstrasse	25
3.1.3 Reference project – Renovation of Kapfenberg, Austria	25
3.2 Façade system 2 – SmartTES Energyfaçade	28
3.2.1 Reference project - The Innova renovation project	31
3.3 Façade system 3 – Smartfront	32
3.3.1 Reference project – Renovation of Lagersberg	35
3.3.2 Reference project – Landsfogden	36
3.4 Façade system 4 – SAPA Building System	37
3.4.1 Reference project – Partille Municipal Office, Sweden	39
3.4.2 Reference project – Vandeputte Offices, Belgium	39
3.5 Façade system 5 – Adaptiwall	41
3.6 Façade system 6 – MeeFS Retrofitting	41
3.7 Façade system 7 – ELEMENTUM eco AB	44
3.7.1 Reference project – Renovation of Brogården, Alingsås	45
4 Methodology	49
4.1 Reference house	49
4.1.1 Building components	51
4.2 Traditional renovation measures vs. multi-active façade systems	52
4.2.1 Advantages and disadvantages	54
4.3 Software tools	56
4.3.1 IDA ICE	56

4.3.2	HEAT2	56
4.3.3	Wikells' Sektionsdata	56
4.4	Energy calculations	56
4.4.1	Traditional renovation measures	59
4.4.2	GAP ³ Solutions	59
4.4.3	SmartTES	60
4.4.4	Smartfront	61
4.4.5	Input data for energy calculations	62
4.5	LCC analyses	63
4.5.1	Prerequisites for the LCC analyses	64
4.5.2	Traditional renovation measures	67
4.5.3	GAP:skin	68
4.5.4	SmartTES	69
4.5.5	Smartfront	69
5	Results	71
5.1	Energy calculations	71
5.1.1	Indoor climate	72
5.2	LCC analyses	73
6	Discussion	79
7	Conclusions	82
8	Further studies	83
9	Summary	84
	References	86

1 Introduction

Sweden's energy goal is to reduce energy use by 20 % by 2020 and by 50 % by 2050, compared to energy use levels in 1995. To reach this goal, it is important to invent energy-efficient renovation solutions that easily can be applied to already existing buildings (Swedisol 2016).

Of all the multi-family buildings in Sweden, approximately 25 % were built during 1961-1970 (SCB 2016). There is large energy-saving potential in these buildings since they are often poorly insulated and do often have a ventilation system without heat recovery. The current renovation solutions for these buildings are to apply traditional additional thick insulation, uniformly airtight construction and new traditional ventilation systems with heat recovery (VVS Företagen 2009). The latter is to make sure the building has a good indoor quality and to keep the tenants satisfied.

The downside of this procedure is that major renovation measures are expensive and not always profitable to carry through. Unfortunately this is one of the reasons why property owners do not want to invest in façade renovations. It can also result in less living space due to internally installed ducts and discomfort from over-heating. Therefore there is a large market potential to invent energy-efficient, profitable and easy to integrate façade renovation solutions, and at the same time to keep the original living space as well as let the tenants stay in their apartments during the renovation time (Adaptiwall I 2016). A multi-active façade system could be the optimum solution for this problem. This is a façade system where both passive and active components are integrated, and it is easily applied to existing buildings and evacuation during the renovation is avoided.

1.1 Background

During the period between 1965 and 1974, 1 005 578 dwellings of different types were built in Sweden (Boverket I 2014). The population in Sweden grew from 7.7 million to 8.2 million and more people moved from the countryside to the inner city. To solve the housing problem, the Swedish parliament decided to build one million dwellings in a ten year period, now called the million program (Formas 2012). The program had a short construction time as the houses were built more rationally, faster and more industrially than during the postwar period (Boverket I 2014). During the construction phase of the million program, there was easy access to cheap oil in Sweden, so oil-fired boilers replaced wood boilers. This cheap energy took the attention away from building highly insulated and airtight buildings. Instead, the ambition was to produce cheap buildings that were easy and fast to construct (Formas 2012).

Many different types of buildings were built during the million program period, such as single family houses and multi-family buildings with variation of stories, but the most built building was the three storey multi-family building (Boverket I 2014). Compared to other time periods, the million program houses were differently constructed. The load bearing structure went from traditional load bearing external walls and internal walls, to load

bearing end walls and partition walls, called the “bookcase structure”. The buildings have a wide variety of façade materials where one third of the buildings have brick façades (Formas 2012).

The current status of these buildings is that approximately 600 000 of 830 000 apartments are in need of renovation (Formas 2012). New piping, installations and replacement of windows, balconies and façades are the most critical measures to save the buildings. The million program houses have often a well-planned layout and can be renovated without any need of tearing down whole apartments to achieve a more energy-efficient layout (Boverket I 2014.)

Since the million program houses are in need of renovation, it is a perfect opportunity to renovate the buildings into energy-efficient buildings (Boverket I 2014). The building envelope has a major impact on the building’s energy use. Also, a ventilation system with heat recovery has a large impact on the energy use and indoor quality. According to Energi & Miljö (2010), although installation of a ventilation system with heat recovery reduces the energy use significantly, it is unfortunately not financially feasible because of the low energy prices in Sweden. The same applies to an addition of external insulation to an existing building. Unfortunately because of its long payback time, property owners decide not to perform these energy-efficient measures. If the building is in need of renovation, however, it is only marginal costs that need to be covered by energy savings (IVA 2012). Another reason why major energy-efficient renovations are not carried out depends on the technical uncertainties. Investors are uncertain if the energy-efficient materials and products will work properly or if there is a better product coming (Mjörnell & Werner 2010).

Decreasing the running costs by energy-efficient renovations can reduce the payback time. The property owners, however, might be forced to raise the rent to be able to carry through the renovation. There is a variety of property owners of the million program houses, from private to municipality owned companies. The apartments can be condominiums or rented apartments. This has a major impact on the financial condition of renovating the buildings (Mjörnell & Werner 2010). Owners of rental properties are responsible for decisions about renovating the building and apartments. Nevertheless, the owners need a confirmation from the tenants for performing major renovations and if there is a necessity to raise the rent. Some of the private property owners do not want to raise the rent since they are afraid they might lose their loyal tenants. The big companies, on the other hand, have a better financial foundation to perform energy-efficient renovations and have the possibility to raise the rent. Another issue is that companies in the public housing sector also have different prerequisites depending on where the buildings are located and their occupancy rate (Mjörnell & Werner 2010).

A multi-active façade may be the solution that can make a renovation profitable for property owners to carry out. Other countries in Europe are further ahead in their development of new energy-efficient solutions for renovations. Austria has developed many different solutions and completed many successful projects. Sweden has a good opportunity to learn and be inspired from these projects. The climate is similar in Austria and in Sweden, so their solutions should be possible to integrate to buildings in Swedish climate zones, at least in climate zone III and IV. Comparing hours of sunshine, Sweden has more sunny hours than

Austria, which means that Sweden has the same capability to produce energy by installing PV-systems and solar thermal systems (Lundgren 2011).

The Faculty of Engineering of Lund University, LTH, has an on-going research project working on developing a concept for energy-efficient renovation of multi-family buildings from the million program period. The objective is to develop a concept for a prefabricated multi-active façade element in collaboration with a couple of technical companies with expertise in different fields such as prefabricated wall constructions, PV-systems, building services etc. The research project started in 2015 and will be completed in the end of 2017. If the project results in a successfully developed multi-active façade concept, the objective is to demonstrate it in a pilot project somewhere in Sweden.

The project group has so far been mapping multi-active façade systems in Europe. They have also been analysing the million program houses, which construction type the buildings have and how many that are in need of renovation, etc. The project group has determined which kind of active solutions that are further investigated.

1.2 Aim and Objectives

The aim of this master's thesis is determine if integrating multi-active façade systems to million program houses are a more energy and cost efficient solution compared to integrating traditional renovations measures separately.

The objective of this master's thesis is:

- To map the under development and developed multi-active façade systems on the market. Investigate what kind of technical solutions that are integrated into these façades.
- To determine if a multi-active façade system is a more energy-efficient solution compared to traditional renovation measures. Also analyse how much the different multi-active façade systems impacts the energy use of a million program house.
- To determine if a multi-active façade system is a profitable solution. Analyse if it is more profitable to install a prefabricated multi-active façade system to a building compared to performing renovation measures separately.
- To achieve BeBo's recommendations of "Reliable Renovation" to reduce the energy use of the reference house by 50 %.

1.3 Scope

In order to accomplish this, three developed multi-active façade systems are studied further and compared to equivalent traditional renovations measures. The traditional renovation measures are: additional external insulation, balanced ventilation-system with heat recovery, window replacement and additional loose wool in the attic.

The multi-active façade systems and traditional renovation measures are divided into cases to calculate their different impacts on the building's energy use. The energy use for each case is obtained in order to continue the Life Cycle Cost, LCC,-analysis. The energy calculations and the LCC analysis are performed using a typical million program house as a reference house. In addition, the indoor climate in the apartments should fulfil the requirements according to the Swedish Public Health Agency.

1.4 Overall approach

The overall approach is summarised in a chart where each working process can be followed, presented in Figure 1.4.1. This master's thesis began with a literature study of the Swedish regulations for renovations and mapping the multi-active façade systems on the market. The market review was continued by a deeper analysis of three different multi-active façade systems, to be able to compare them with traditional renovation methods. Simultaneously the reference house was studied, and its energy performance was calculated. A parametric study was performed to analyse each measures impact on the reference house's energy use. All traditional renovation measures were then calculated and a comparison between all cases was carried out from both the energy and LCC perspective. The result of the LCC analysis was more deeply investigated by performing sensitivity analyses, where the real rates of interest, annual district heating price change and calculation time were varied.

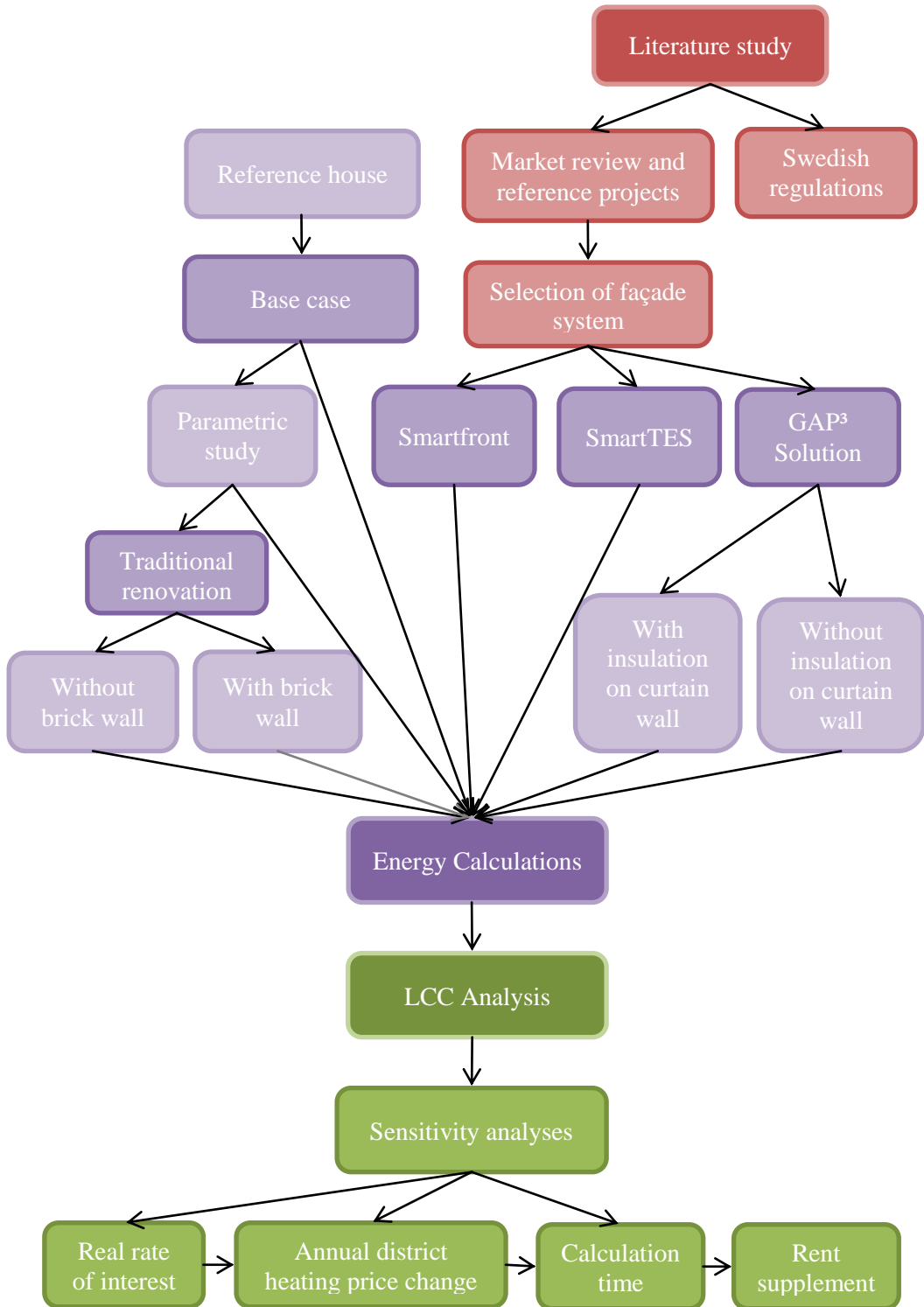

Figure 1.4.1: Overall approach chart.

1.5 Limitations

The results are based on the geographical location of Malmö and are not analysed for other climate zones.

Normally the different multi-active façades are integrated with a specific window type. To be able to compare the different solutions in this master's thesis, the same types of windows were used for the different solutions.

No moisture analysis was carried out to make sure integrating the multi-active façade systems to existing buildings are moisture safe. However, this must be carried out in real projects.

No daylight analysis was carried out to determine the impact of applying external insulation on the façade and placing the new windows further out in the façade.

Detailed technical solutions, such as extension of eave, base, joints, sealing and attachment of the studied systems, are not deeply investigated in this master's thesis. The detailed technical solutions are assumed to be working properly as the companies behind the multi-active façade systems explain they do.

1.6 Terminologies

Abbreviations

AHU	Air Handling Unit
BIPV	Building Integrated Photovoltaics
DHW	Domestic Hot Water
EPS	Expanded Polystyrene
FRP	Fibre Reinforced Polymer
IDA ICE	IDA Indoor Climate and Energy
MSEK	Millions of Swedish Kronor
LCC	Life Cycle Cost
LTH	The Faculty of Engineering of Lund University
NPV	Net Present Value
PBL	Plan and Building Law

PV	Photovoltaic cell
SFP	Specific Fan Power
THEX	Total Heat Exchanger

Mathematical notations

A_1	Future value	[SEK]
g	Annual real price change	[%]
i	Annual real rate of interest	[%]
N	Calculation time	[years]
P	Present value	[SEK]
U-value	Heat loss coefficient	[W/(m ² ·K)]

1.7 Contributions

The work was divided equally between the two authors. All ideas and decisions have been made together by discussions.

2 Literature study

This chapter contains a literature study about Swedish regulations for energy-efficient renovations and the tenants' right during renovation. The literature study also contains on-going research projects developing solutions for energy-efficient renovations.

2.1 Swedish building regulation

This subchapter explains some of the Swedish building regulations and recommendations for renovation of multi-family buildings.

2.1.1 Energy regulations

Sweden is divided into four climate zones. For climate zone IV, in the south part of Sweden, the energy use of a multi-family building should not exceed 75 kWh per m² heated floor area. This applies to a new building with a heating system other than electricity. If the building does not meet this criterion when renovating the building envelope, the U-values of the building components presented in Table 2.1.1.1, should be strived to reach. The airtightness of the building envelope is fulfilled if the regulations for the building's energy use and power output for heating are met (BBR 2015).

Table 2.1.1.1: Recommended U-values to be strived to reach for different building components when performing changes in the building envelope (BBR 2015).

Building components	U-value /(W/(m²·K))
Roof	0.13
Wall	0.18
Ground floor	0.15
Windows	1.2
Doors	1.2

If the building envelope is being airtightened, the outdoor air inlet should be ensured. When applying exterior additional insulation, the impact on the building's characteristics and details such as windows and doors, and the relation between the façade and the base and the eave should be considered. The window should e.g. be moved out in the façade to keep the original building design (BBR 2015).

2.1.2 Maintenance or reconstruction of the building

The term maintenance refers to "one or more measures to which are intended to maintain or restore the building construction, function, usage, appearance or heritage value" (Boverket II 2014 p. 10). The term reconstruction refers to "change of a building which means the whole building or a meaningful part and definable part of the building are significantly renewed" (Boverket II 2014 p. 12). According to Swedish law, reconstruction needs to fulfil new construction requirements. The Swedish Plan and Building Law, PBL, is often

discussed, because the line between maintenance and reconstruction is vague since the two concepts unavoidably overlap each other. A typical maintenance measure is e.g. changing an old metal sheet roof so its original function of waterproofness is kept, while it is clear that choosing a different colour of a metal sheet roof changes the building's appearance and operation and is therefore a reconstruction according to the PBL (Boverket II 2014).

Boverket, the National Board of Housing, Building and Planning, invited relevant authorities, county councils and municipality organisations for property developers, building permit reviewers, building inspectors, et al. Forty people participated in the workshop which began with a review of the Swedish building regulations. They were given a number of different scenarios to consider and were asked to judge if the scenarios were maintenance or reconstruction (Boverket II 2014).

“Façades, roof, installations changed, but the building itself adds no new functions.
Is this reconstruction?” (Boverket II 2014 p. 25).

Yes: 14 %

No: 71 %

Unsure: 14 %

The magazine Bofast published in 2012, a survey asking which type of requirement the municipals required in some renovation scenarios. The basis for this article consisted of a questionnaire that was answered by almost 50 % of the Municipalities in Sweden and was also supplemented with a number of telephone interviews (Boverket II 2014).

“Window replacement + additional insulation on walls and roof + change of ventilation.
Requirements for accessibility?” (Boverket II 2014 p. 28).

Yes: 11 %

No: 64 %

Perhaps: 21 %

Do not know/not taken a stand: 4 %

In both surveys, the people mentioned that they have a rule of thumb; if the renovation cost exceeds 25 % of the new production cost of an equivalent building, reconstruction requirements should be applied, this however, is not mentioned in the PBL (Boverket II 2014).

2.1.3 Municipal housing companies

Municipal housing companies are not allowed according to the Swedish regulations to set aside money for major renovations. Parts of the renovation are financed with a raised rent for the tenants (Förvaltaren 2015).

The Tenants Association is a Swedish democratic membership organization. The Tenant Association's main role is to negotiate the rent with the municipal public housing companies and private property owners. According to the Tenants Association, no limits for how much the rent can be increased after a renovation exists. The rent must still be equitable, reasonable and based on the apartment's utility value (Hyresgästföreningen 2016).

The Tenants Association's member's magazine Home & Rent (Hem & Hyra 2013) performed a survey where 51 housing companies participated. They were asked about the rent supplement that was applied after they performed interior renovations in their million program houses. For a three room apartment of approximately 70 m², the median rent supplement was 736 SEK/month. The average rent supplement was 882 SEK/month, because some housing companies had raised their rent between 2 000-3 000 SEK/month (Hem & Hyra 2013). The rent supplements made by housing companies close to Landskrona are presented in Table 2.1.3.1.

Table 2.1.3.1: Rent supplement by housing companies after renovations (Hem & Hyra 2013).

Municipal public housing company	Distance from Landskrona/km	Rent supplement SEK/month
Kristianstad Österäng, ABK	100	1500
Malmö, Holma, MKB	43	900
Halmstad, Andersberg, HFAB	99	837
Halmstad, Grönevång, HFAB	99	570
Helsingborg, Stattena, Helsingborgshem	27	460
Karlshamn, Svängsta, Karlshamnsbostäder	156	280

2.1.4 Tenants' right during renovation

The property owner is allowed to perform maintenance without the tenants' permission, such as painting, new flooring and replacing the oven etc., things that already exists does not raise the standard of the apartment. However, if the property owner wants to renovate the apartment, the property owner is obliged to inform the tenants. The property owner is not allowed to renovate the apartment without the tenants' permission, but the property owner can get permission from the rent tribunal if they believe the renovation is necessary. If the renovation raises the standard of the apartment, the property owner is allowed to raise the rent. The rent supplement is negotiated before, during or after the renovation between the Tenants Association and the property owner. The rent is commonly raised in steps so that it becomes higher every year for a couple of years (Boverket III 2014).

The tenants have rights to get compensated if they experience disturbance during the renovation, such as noise, dust or not having access to bathroom or kitchen. if the renovation is extensive the tenants can be evacuated and moved to an equivalent evacuation apartment during the renovation period (Boverket III 2014).

2.2 The Swedish Energy Agency financed network BeBo

BeBo is a network of property owners from the residential sector financed by the Swedish Energy Agency, where Landskronahem AB is one of their members. The network's main objective is to reduce the energy use of multi-family buildings, which is achieved by the activities of the network members that includes investigating, demonstrating and evaluating new solutions. Another objective is to promote and introduce energy-efficient technologies. BeBo's work leads to that energy-efficient systems and products faster reaches the market and the property owners, since the members share information and knowledge in between them, and all results are made available to property owners outside the network and the public in general via the BeBo webpage (BeBo 2016).

BeBo has developed a method called Reliable Renovations which helps property owners to achieve energy-efficient renovation to their properties, which reduces the energy use by at least 50 %. A technical procurement of rational methods for additional insulation has been performed within BeBo, where some of the systems described in the market review were participating (BeBo 2016).

2.3 Nordic Built

WSP Group is one of the partners in the Nordic Innovation project Nordic Built Active roofs and façades in Sustainable Renovation (2016). WSP obtains financial funding from the Swedish Energy Agency to enhance sharing and comparing of experiences from renovation projects with other partners from Nordic countries (Karlsson 2015).

The Active roofs and façades project started in 2014 based on the lack of solutions for sustainable renovation which are possible to integrate to existing buildings with respect to architecture, comfort and energy-efficiency on the Nordic market. The objective of the project is to develop concepts for integrated prefabricated solutions such as active façade and roof elements, including the integrated use of solar energy. Also to demonstrate that integrated prefabricated solutions work well in practice and are beneficial for many stakeholders, including the renovation company, property owner and tenants. The project will be completed in 2017 (Nordic Built 2014).

So far some of the project's objectives have been met. Active solutions are being investigated and discussions and exchange of experience from earlier projects have started (Energimyndigheten 2016).

2.4 Multi-active façade definition

Retrokit is an on-going project developing prefabricated multi-functional façades, they define multi-functional façades as: specially developed insulating elements allowing insulation, heating pipes, ventilation, electricity and information and communication technology to be integrated flexibly. (Fraunhofer ISE 2016)

The project group at LTH defines a multi-active façade element as:

- A building envelope integrated with additional insulation in combination of integrated active heating and ventilation systems as a prefabricated façade element (E2B2 2015).
- A multi-active façade element insulates, ventilates and heats the apartments as well as it produces renewable energy (E2B2 2015).

A multi-active façade is a wall construction where both passive and active components are integrated. Passive components are e.g. thermal insulation, wind barrier, etc., and their purpose is to fulfill the requirements for: thermal, fire and moisture properties. Active components are components which distribute and produce energy, such as ventilation system, heat exchanger, PV-system, etc¹. Multi-active façade systems can be used for new constructions and existing buildings (GAP³ Solutions I 2016).

¹ *Susanne Gosztonyi, Dip. Ing. Architect at LTH. Presentation, 31 March 2016.*

3 Market review and reference projects

This chapter contains a market review of some multi-active façade systems that are developed or under development in Europe. Some systems cannot be classified as multi-active yet, but are in progress in research projects and are therefore mentioned in this market review. Some multi-active façade systems have been integrated to existing buildings in real projects. In this master’s thesis they are called reference projects and they explain the multi-active façade system’s feasibility and reached expectation. A summary of the studied façade systems and reference projects are presented in Table 3.1. The façade systems that are further investigated and used in the energy and LCC analyses in this master’s thesis are highlighted in bold.

Table 3.1: Summary of the façade systems and the reference projects where they have been integrated.

Façade system	Reference projects
GAP³ Solutions	Graz Dieselweg, Linz Makartstrasse & Kapfenberg
SmartTES	Innova
Smartfront	Lagersberg & Landsfogden
SAPA building system	Partille municipal office & Vandeputte offices
Adaptiwall	-
MEEFS	-
ELEMENTUM eco	Brogården

3.1 Façade system 1 – GAP³ Solutions

GAP³ Solutions are three different façade solutions called GAP:skin, GAP:air and GAP:water. The main idea behind the façade solution GAP:skin is its ability to store heat in the façade from solar radiation. Their innovative component in the façade system is a honeycomb structure made of the organic material cellulose which acts differently depending on the angle of the sun. During the winter months when the angle of the sun is low, the rays from the sun hit the honeycomb structure and penetrate deep into the construction. The sun rays converts into heat which increases the temperature further in the construction. During the summer months, the honeycomb will act like a buffer and the structure itself will self-shade due to the high angle of the sun rays, see Figure 3.1.1 (Treberspurg & Djalili 2010).

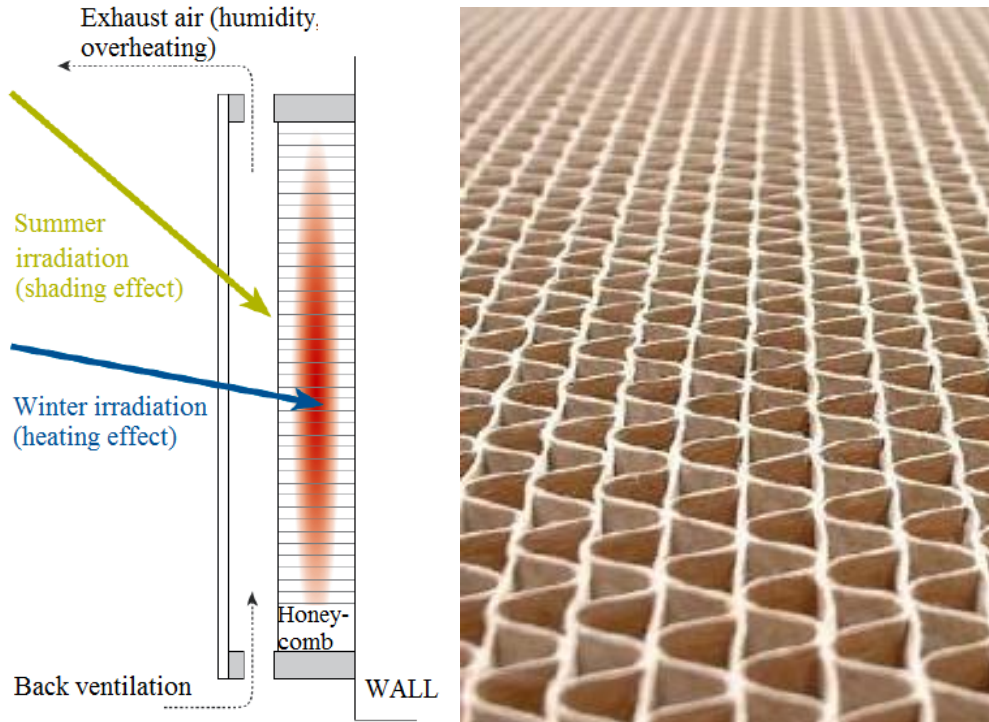

Figure 3.1.1: (Left) Solar rays hitting the honeycomb structure. (Right) Close up of the honeycomb structure (GAP³ Solutions 2016).

The honeycomb structure has a high sound absorption and is protected from weather and possible damage by a glass panel. The U-value of the GAP:skin varies from 0.02 W/(m²·K) to 0.18 W/(m²·K), depending on which orientation it faces. From an architectural point of view the GAP:skin has its advantages, because the honeycomb can be painted in any colour and the façade gets different expressions depending on the structure of the glass that is chosen. See Figure 3.1.2 for different glass structures (Treberspurg & Djalili 2010).

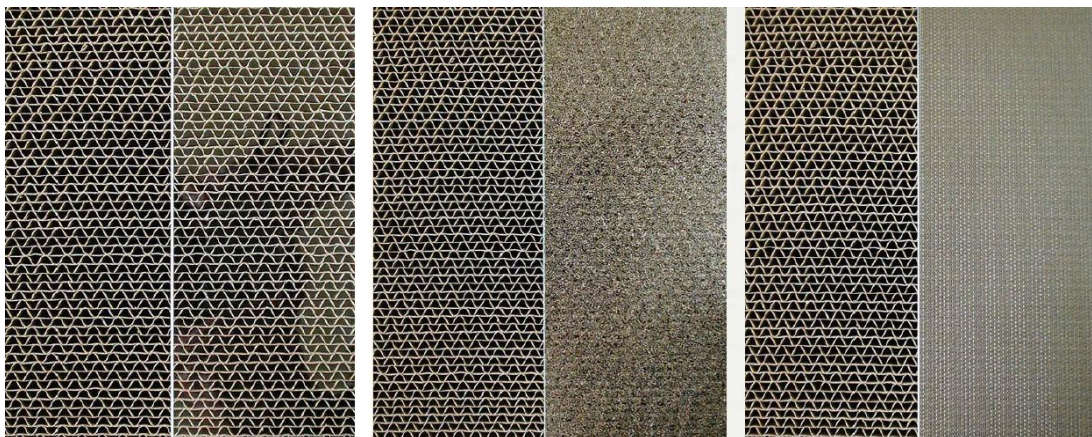

Figure 3.1.2: Three variations of glass structures compared to the honeycomb structure: (Left) Floatglass blank (Middle) Ornamente glass (Right) Textured glass (GAP³ Solutions 2016).

The GAP:skin can be integrated to both new constructions and existing buildings. The element used for integration to existing buildings consists of a framework and a GAP-panel, see Figure 3.1.3. The framework is made of solid wood with 151 mm insulation, and the GAP-panel consists of a 19 mm wood panel, 30 mm GAP-honeycomb panel, 28 mm slightly ventilated air gap and 6 mm ESG float glass panel attached to aluminium parts (GAP³ Solutions I 2016).



Figure 3.1.3: GAP:skin for renovation projects (GAP³ Solutions 2016).

The GAP:air is a ventilation element which preheats the fresh air in the façade before it is supplied into the building, see Figure 3.1.4 (GAP³ Solutions II 2016).



Figure 3.1.4: GAP:air element, where the white box is placed on the inside of the wall (GAP³ Solutions 2016).

The GAP:water CC is a façade element which is used as a support to the Domestic Hot Water, DHW, delivered by district heating or other sources. Water pipes are integrated in the core element which consists of concrete. This layer is covered by a 3-glazed window. The rays from the sun pass through the window and heat up the concrete which works as an absorber. The water in the pipes which passes through the concrete is heated up and goes into a boiler inside each apartment (GAP³ Solutions III 2016). The GAP:water CC is presented in Figure 3.1.5.

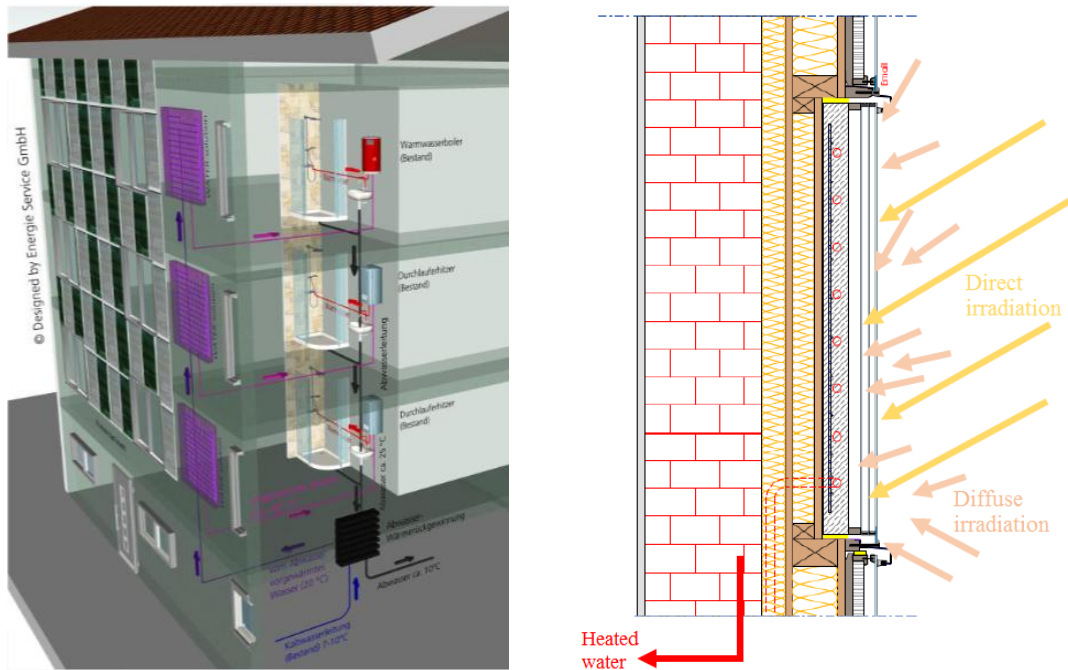

Figure 3.1.5: (Left) GAP:water CC, overall installation with Waste Water Energy Recovery System. (Right) Technical section of the GAP:water CC solution (GAP³ Solutions 2016).

The GAP: water CC can be complemented with a PV-system, which that for example is located on the façades or at the roof of the building. This system is called GAP:water PV, and contains PV cells instead of the concrete core with water pipes. The PV-system is connected to the boiler in each apartment, which in turns heats the water. The PV-system can also be connected to the grid or to a common central in the building. Unlike the GAP:water CC, which can take advantage of both direct and diffused sunlight, the GAP:water PV only works in direct sunlight (GAP³ Solutions III 2016). The GAP:water PV, is presented in Figure 3.1.6.



Figure 3.1.6: GAP:water PV, overall connection with Waste Water Energy Recovery System (GAP³ Solutions 2016).

3.1.1 Reference project – Renovation of Graz, Dieselweg

The project contains several buildings located in a block. They were built in 1952 to 1970 in Graz, Austria, and were renovated with GAP³ Solutions during 2008 to 2010. Figure 3.1.1.1 presents the building design of one of the renovated buildings, before and after integrating the GAP³ Solutions (AEE INTEC 2010).



Figure 3.1.1.1: (Left) Before the renovation. (Right) After integrating GAP:skin. (GAP³ Solutions 2016).

Along with the new façade, new windows and roof were mounted and the ventilation system was improved with heat recovery (AEE INTEC 2010). The measured heating demand in the buildings was reduced by 89-95 % and the U-values of the building components were substantially improved, see Table 3.1.1.1(Giwog n.d.).

Table 3.1.1.1: U-values of building components before and after renovation (Geier 2009).

Building components	U-value before renovation/ (W/(m ² ·K))	U-value after renovation/ (W/(m ² ·K))
Façade	1.28	< 0.20
Roof	1.50	< 0.2
Windows	> 2.0	> 0.85
Ground floor	Unknown	< 0.20

3.1.2 Reference project – Renovation of Linz, Makartstrasse

The buildings in Linz, Austria were built in 1957 and were in need of a renovation, which took place in 2005 to 2006. The façades were renovated with GAP³ Solutions, see Figure 3.1.2.1 for pictures before and after the renovation (Aschauer 2006).



Figure 3.1.2.1: (Left) Before the renovation. (Right) After the integration of GAP:skin (GAP³ Solutions 2016).

Along with the new façade, new windows and roof were mounted, and the ventilation system was improved with heat recovery. The renovation measures reduced the space heating demand by 92 % (Aschauer 2006).

3.1.3 Reference project – Renovation of Kapfenberg, Austria

GAP³ solution was involved in the renovation research project in Kapfenberg, Austria. The building in Kapfenberg was built in 1960-1961 and is a four storey building, presented in Figure 3.1.3.1. The renovation started in 2012 and finished in the beginning of 2014. The project's objectives were to reduce the energy use by 80 % and reduce the CO₂ emission by 80 %. Also, 80 % of the renovated building's energy use would be provided by renewable energy sources (Höfler, Knotzer & Venus 2015).



Figure 3.1.3.1: Kapfenberg building before renovation. (AEE INTEC 2015)

The building got a new roof and new façades, where prefabricated façade elements for building services were integrated together with prefabricated passive façade elements. New windows were integrated in the prefabricated façade elements, which were integrated vertically to the building. A PV-system was installed on the roof and on the south façade along with a solar thermal system, and a balanced ventilation system with heat recovery was installed to improve the indoor climate (Höfler, Knotzer & Venus 2015). The U-values of the building components before and after the renovation are presented in Table 3.1.3.1.

Table 3.1.3.1: U-values of building components before and after renovation (Höfler, Knotzer & Venus 2015).

Building components	U-value before renovation/ (W/(m ² ·K))	U-value after renovation/ (W/(m ² ·K))
Façade	0.87	0.17
Ceiling	0.39	0.30
Roof	0.74	0.10
Windows	2.50	0.90

The prefabricated elements for building services were integrated between the passive façade elements. The elements for buildings services were designed to be operable for easy accessibility in need of service or repair, see Figure 3.1.3.2. The elements can fit different types of ducts and pipes, for example heating, ventilation, supply water and waste water. In this project, ventilation ducts and supply and waste water pipes were integrated in the elements (Höfler, Knotzer & Venus 2015).



Figure 3.1.3.2: Picture of the integrated elements with building services, without the external layer (AEE INTEC 2015).

The calculated energy use was reduced by 75 % and the electricity use by 51 % (IEA EBC Annex 56 2014). The final building design is totally different compared to the original, see Figure 3.1.3.3.



Figure 3.1.3.3: Kapfenberg after renovation, notice the integration of the covering of the building service elements (AEE INTEC 2015).

3.2 Façade system 2 – SmartTES Energyfaçade

TES EnergyFaçade method was developed within an international research project in 2008 to 2009, founded by Woodwisdom Net. The TES EnergyFaçade method provides a cost-efficient solution and faster mounting process on site reducing disturbance for tenants. The TES EnergyFaçade element is an insulated timber framed prefabricated façade element where the timber framework is the load bearing structure, filled with insulation and covered with cladding. The element has a wide variety of cladding options and possibilities to integrate components, e.g. windows, solar energy systems and buildings services. The element can be mounted on an existing building or used as a new wall construction (TES EnergyFaçade 2016). Before mounting the TES EnergyFaçade on existing wall, an adaption layer needs to be applied to avoid unevenness of an existing façade and at last the preferred cladding layer will be mounted (TES EnergyFaçade 2009). The basic TES EnergyFaçade element is presented in Figure 3.2.1.

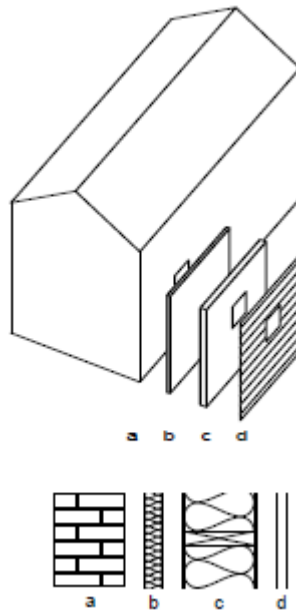

Figure 3.2.1: Basic TES EnergyFaçade element, steps of appliance to existing building. a) Existing wall b) Adaption layer c) TES EnergyFaçade d) Cladding.(TES EnergyFaçade 2009)

The multi-functional TES EnergyFaçade element, called SmartTES, is an on-going European research project also founded by Woodwisdom Net. The project is based on the TES EnergyFaçade project with an objective to advance the sustainable method of energy-efficient modernisation with large-scale prefabricated timber elements (Ott et.al. 2014). The SmartTES element is presented in Figure 3.2.2.

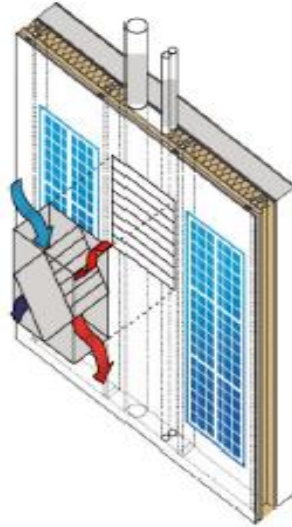

Figure 3.2.2: SmartTES element. (TES EnergyFaçade 2014)

There are three principles for technical installations in the building façade: TES-integrated, TES-connected and TES-envelope, see Figure 3.2.3 (Ott et.al. 2014).

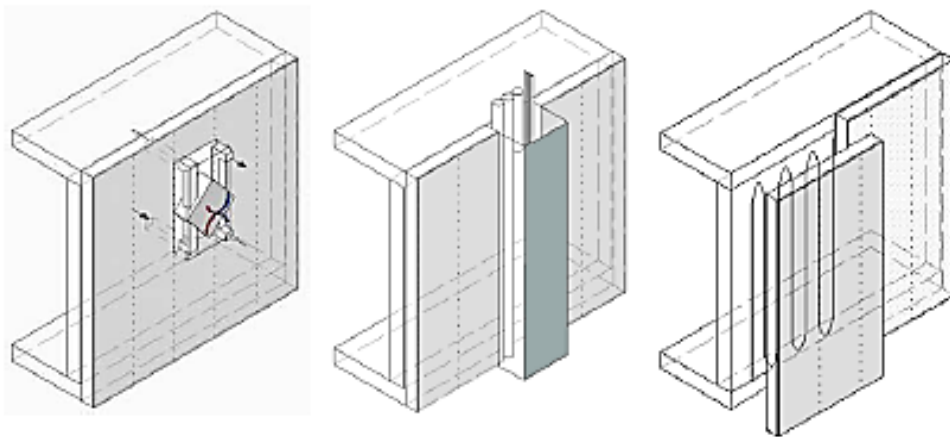

Figure 3.2.3: The three categories of the façade elements: (Left) TES-integrated. (Middle) TES-connected (Right) TES-envelope (TES EnergyFaçade 2014).

The first category of the façade elements is the TES-integrated, where Air Handling Units, AHU, micro heat pumps and daylight direction systems can be integrate. The size and shape of mechanical and electrical components integrated to the façade element are limited to the element area. Therefore the components cannot supply for the whole building, instead they supply for smaller areas, such as apartments. For example can an integrated air heat pump supply heat for an apartment up to 75 m², since it only can reach a power of 1-2 kW. The components are attached to the timber framework. The required insulation thickness, normally ≥ 200 mm, decides the possible depth of the components. The façade element consists of a uniform insulation layer and the integrated components must be installed

correctly to avoid thermal bridges. PV-system and solar thermal collectors are possible to integrate in the façade cladding or to replace the cladding, see Figure 3.2.4 (Ott et.al. 2014).

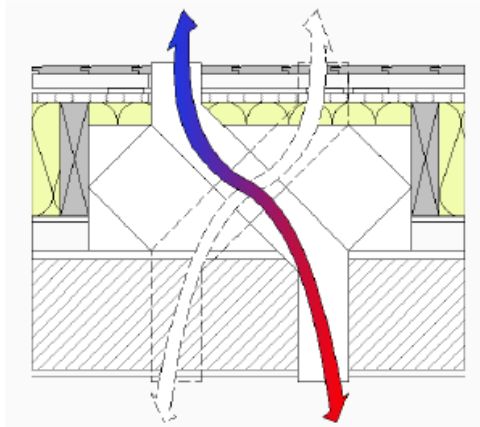

Figure 3.2.4: Horizontal section of TES-integrated façade element with heat-recovery (TES EnergyFaçade 2014).

The second category of the façade elements is the TES-connected, where ventilation ducts, water pipes for fresh water, heating and waste water, electricity and installations can be integrated. The routing can be connected to one or more TES-elements. The advantage of this prefabricated façade element is better streamlining of processes and fewer errors on site. The problem with this façade element is the dimension of ducts, keeping clear from collisions with joints, the assembly of the prefabricated element and its thermal properties. To avoid heat losses and freezing of pipes, all ducts and pipes must be covered with a non-flammable insulation with a minimum thickness of the nominal diameter, see Figure 3.2.5. Decoupling of the installations is required to avoid impact sound generation and to limit fire spread via the ventilation ducts. For easy maintenance, the ducts and pipes are recommended to be integrated with easy accessed openings (Ott et.al. 2014).

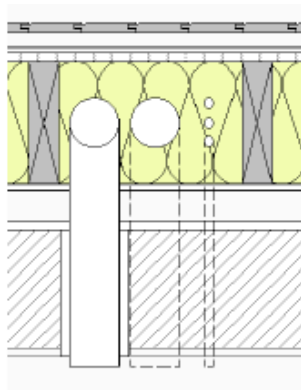

Figure 3.2.5: Horizontal section of TES-integrated façade element (TES EnergyFaçade 2014).

The third category of the façade elements is the TES-envelope, where the active envelope consists of thin heating pipes with reverse flow of a solar thermal plant. The pipes are integrated on the side of the TES-envelope façade element, see Figure 3.2.6. The purpose of this façade design is to heat the existing external wall (Ott et.al. 2014).

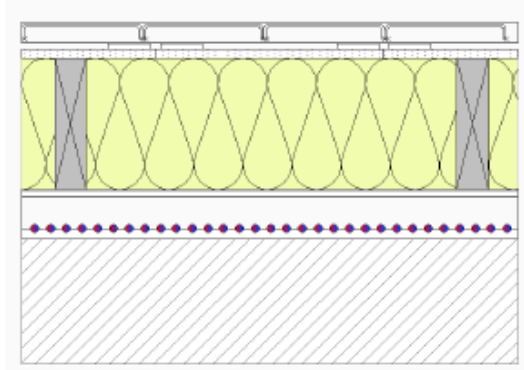

Figure 3.2.6: The TES-envelope façade element with thin pipes which is presented as dots in picture (TES EnergyFaçade 2014).

3.2.1 Reference project - The Innova renovation project

A multi-family building in Riihimäki, Finland, was renovated using the TES method. SmartTES prefabricated façade elements with integrated supply air ducts were mounted to the existing building while, the existing exhaust air ducts were kept, see Figure 3.2.1.1. A centralized ventilation system with a rotating heat recovery was installed for easy maintenance and for not making the tenants responsible for the frequently change of filters (Ott et.al. 2014).

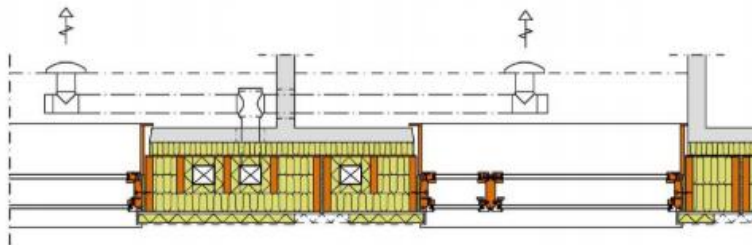

Figure 3.2.1.1: Detail of the SmartTES element with integrated ventilation ducts and windows (TES EnergyFaçade 2014).

The building had to be scanned by a 3D laser to be able to design perfectly matched prefabricated façade elements. The first step of the renovation was to tear down the outer concrete layer and insulation of the sandwich element, followed by removing the old windows and doors. An adaption layer of insulation was then applied to avoid unevenness of the existing façade (Ott et.al. 2014). The different steps are presented in Figure 3.2.1.2.

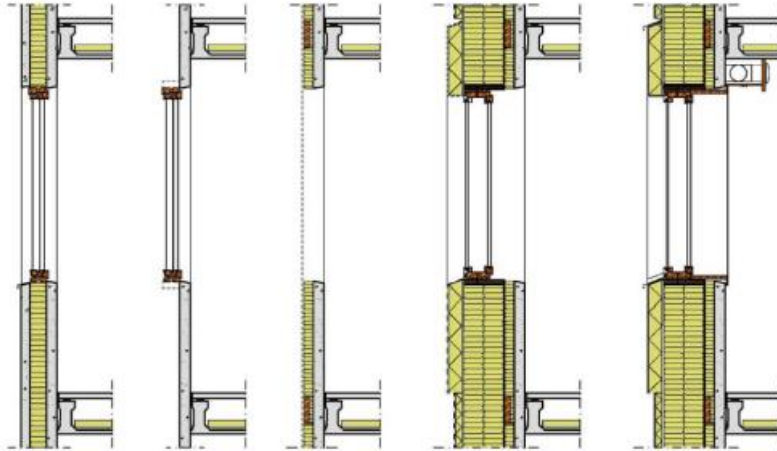

Figure 3.2.1.2: The façade renovation in steps: from the old external wall (left) to the new wall with integrated SmartTES element (right) (TES EnergyFaçade 2014).

The SmartTES element with integrated ventilation ducts, windows and doors was mounted vertically to the existing façade, but the cladding was mounted on site. The façade renovation improved the building components' U-value significantly, see Table 3.2.1.1 (Ott et.al. 2014).

Table 3.2.1.1: The U-values before and after renovating with SmartTES (Ott et.al. 2014).

Building components	U- value before renovation/ (W/(m ² ·K))	U- value after renovation/ (W/(m ² ·K))
Load bearing external wall	0.27	0.1
External wall	0.25	0.1
Doors	1.8	0.8
Windows	2.9	0.66

3.3 Façade system 3 – Smartfront

Smartfront is a renovation method which implies addition of external insulation, replacement of windows with low U-value and installation of ventilation system with heat recovery. Smartfront is owned by Front AB which is a Swedish company focused on façade renovations. Smartfront was developed in 2013 and has during the past three years demonstrated two pilot projects in Sweden. Smartfront are partners with the Swedish subcontractors Paroc (insulation), Fläktwoods (AHU), SP fönster (windows) and STO (rendering) (Smartfront 2015). Smartfront is one of the companies involved in the on-going research project developing a multi-active façade system in collaboration with LTH.

Detailed construction of the Smartfront façade (Paroc group I 2016):

- 80 mm PAROC, Smartfront board, with integrated 80 mm supply air ducts
- 100 mm PAROC, Fatio
- PAROC XFR 300, Rendering attachment
- PAROC XNR 001, Net plaster
- PAROC XFN 003, Net holder
- Three separate layers of lime cement render.

Smartfront is unlike the other solutions in this market review not a prefabricated façade element (Smartfront 2016). The mounting occurs externally on site where 80 mm supply air ducts are placed the 180 mm fire safe insulation in the façade and covered with thick rendering. For each inlet, one duct is installed with a maximum angle of 45° on the façade, see Figure 3.3.1. The existing exhaust air system is supplemented with airtight lining hoses and connected to the AHU, which is installed in the attic or on the roof (Smartfront 2015).



Figure 3.3.1: (Left) Smartfront façade system with integrated supply air ducts. (Right) Supply air duct installed with a maximum angle of 45° (Smartfront 2016).

Additionally, Smartfront install smoke dampers and applies 400 mm fire safe insulation in form of loose wool in the attic. The maintenance of the ventilation system is minimal due to effective filters. The supply air devices are installed underneath the radiators, to reduce the risk of drafts and to spread the heat from the radiators evenly (Smartfront 2016). The Smartfront's supply air device is presented in Figure 3.3.2.



Figure 3.3.2: Smartfront's supply air device (Smartfront 2016).

The replacement of windows occurs with the existing windows still integrated. The new windows are integrated with a mounting frame holding the window in place while fastening it to the existing window frame. This method prevents the tenants from being evacuated or compensated since the construction workers only need few visits to the apartments (Smartfront 2016). The window mounting process is presented in Figure 3.3.3.



Figure 3.3.3: Window mounted outside the existing window using mounting frames (Smartfront 2016).

3.3.1 Reference project – Renovation of Lagersberg

The project in Lagersberg located in Eskiltuna was carried out with financial funding from the Swedish Energy Agency. The objectives of the project were to reduce the energy use by >50 % and to renovate the façades of the buildings. Smartfront was integrated to one of the buildings, which is presented in Figure 3.3.1.1 (Karlsson & Levin 2015).



Figure 3.3.1.1: Lagersberg before the renovation (Smartfront 2015).

The building was followed up after the renovation by investigating possible heat losses in the façades. The thermography was performed during a cold winter day in February, which showed a small heat loss where the ducts were integrated in the façade. The integrated ducts can be seen within the red circle in Figure 3.3.1.2 where the red coloured parts have high amount of heat loss and the dark blue parts have small amount of heat loss (Karlsson & Levin 2015).

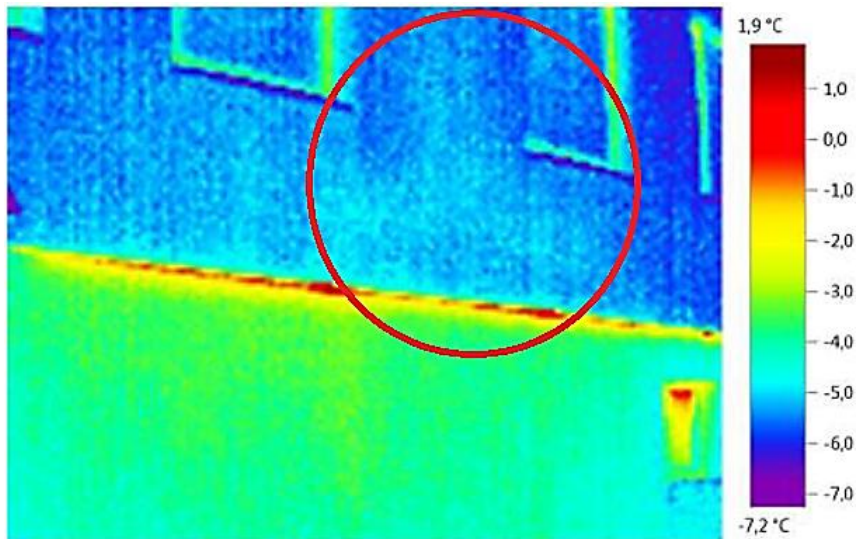

Figure 3.3.1.2: Variation of temperatures on the façade (Smartfront 2015).

This small heat loss from the ducts was accepted and the project was seen as successful since the measured heating use reduced by 60 % (Karlsson & Levin 2015). The measured and calculated energy use of the project is presented in Table 3.3.1.1.

Table 3.3.1.1: The measured and calculated annual energy use of the building before and after the renovation with Smartfront. Produced energy from integrated PV-system is added to the building electricity (Karlsson & Levin 2015).

Annual energy use	Before renovation /(kWh/m²)	After renovation /(kWh/m²)
Heating demand	94.6	37.5
DHW	36.7	33.7
Building electricity	19	7.8
Measured energy use	150	79
Calculated energy use	158	74
Household electricity	26	29

Although, the buildings got a new colour on the façades the building characteristics were kept the same (Karlsson & Levin 2015). The new façade is presented in Figure 3.3.1.3.



Figure 3.3.1.3: The final result after renovating with Smartfront (Smartfront 2015).

3.3.2 Reference project – Landsfogden

The neighbourhood of Landsfogden located in Stockholm, Sweden, was the second pilot project where Smartfront was integrated. The buildings were built in 1950, and consisted of 90 apartments. The buildings were in need of a façade renovations (Paroc Group II 2016). Smartfront was mounted with a similar colour of the rendering to keep the same appearance as before the renovation, which was one of the objectives within the project², see Figure 3.3.2.1.

² Stefan Forsberg, project manager at Smartfront. Presentation, 31 March 2016.



Figure 3.3.2.1: The façade of the buildings in the neighbourhood of Landsfogden after the renovation using Smartfront. (Smartfront 2016)

The objective was also to reduce the energy use of the buildings. The project was successful since the heating cost reduced by 80 %. The project in Landsfogden was nominated to the “Building of the year” by the Swedish magazine Construction industry (Byggindustrin) and Swedish construction services (Svensk Byggtjänst) (Paroc Group II 2016). In addition, the property owner Einar Mattson bygg AB won Sweden Green Building Council’s price for their innovative sustainability efforts within this project (My News Desk 2014).

3.4 Façade system 4 – SAPA Building System

SAPA façade system is based on that different materials such as glass, sheet metal, cement-based panels, or photovoltaic cells can be mounted between aluminium profiles. If installing integrated PV-systems on the façade, the aluminium profiles will work as installation duct, and as a ventilated air gap which will remain cold. The photovoltaic cells system is called SAPA Solar BIPV where the cell is placed behind a glass panel, in the selected zones of the façade. The insulation material is installed behind the façade skin. SAPA façade 4150 EF/4150 EF SX is a prefabricated façade element that can be combined with all the different modules, e.g. windows and PV-cells (Mjörnell & Blomsterberg 2014).

SAPA Solar BIPV means Building Integrated Photovoltaics. The system gives the architect and planners the opportunity to integrate the PV-system into the building design. The PV-system replaces the building envelope with the same functionality as a traditional cladding and works at the same time it as a provider of electricity. See Figure 3.4.1 and Figure 3.4.2 for different BIPV designs and functions (SAPA Building System 2012).



Figure 3.4.1: (Left) Insulated glass, see-through Monocrystalline. (Right) Singel glass, opaque Polycrystalline (SAPA Building System 2016).



Figure 3.4.2: (Left) Insulated glass, see-through thin film. (Right) Single glass, opaque thin film (SAPA Building System 2016).

SAPA Façade 4150 EF SX is a well-insulated façade element with aluminium profiles. The internal sealing tape optimizes its thermal performance and the three steps sealing of rubber strips between the elements simplify the mounting process, see Figure 3.4.3. (SAPA Building System 2016)

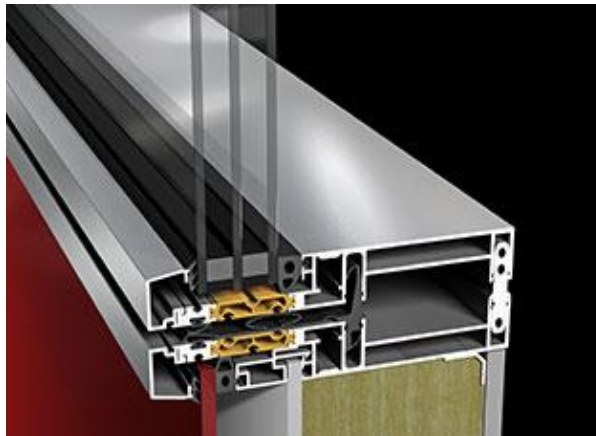

Figure 3.4.3: SAPA Façade 4150 EF SX (SAPA Building System 2016).

3.4.1 Reference project – Partille Municipal Office, Sweden

The newly built head entrance of Partille municipal office in Sweden is built by integrating SAPA façade 4150 and SAPA Solar BIPV. The glass parts consist of monocrystalline cells in a 2-glass insulated unit. The U-value of the façade is 1.1 W/(m²·K) (SAPA Building System 2012). The head entrance is presented in Figure 3.4.1.1.



Figure 3.4.1.1: Integrated SAPA Solar BIPV in the façade of head entrance of Partille Municipal Office in Sweden. (SAPA Building System 2012)

3.4.2 Reference project – Vandeputte Offices, Belgium

The new constructed warehouse with adjacent offices has an active glazed façade of insulated BIPV elements (SAPA Building System 2012). The warehouse is presented in Figure 3.4.2.1.



*Figure 3.4.2.1: BIPV façade of Vandepuut office in Oosterzele, Belgium.
(SAPA Building System 2012)*

The BIPV elements provide electricity, reduce solar load and the risk of glare. The building was integrated with 22 BIPV elements, where each element produces 410 W_{peak} power, see Figure 3.4.2.2 for the BIPV elements (SAPA Building System 2012).



Figure 3.4.2.2: BIPV façade elements (SAPA Building System 2012).

3.5 Façade system 5 – Adaptiwall

Adaptiwall is a façade element which currently is under development. The prefabricated façade element is multi-functional and lightweight based on adaptive insulation and nanomaterials. Adaptiwall’s objective is to develop a cost-efficient and energy-efficient façade system which reduces the heating and cooling demand by 50-80 % compared to current solutions for additional insulation. The façade system will be a quick solution for renovation of existing façades. Their objective is also to reduce or exclude auxiliary heat recovery and ventilation installations, reduce of the envelope thickness by 30 % and reduce 50 % of its weight to save space and reduce dead load. Also, to fulfil the requirement for load bearing, fire safety and sound insulation functions (Adaptiwall II 2016).

The Adaptiwall consists of lightweight concrete, adaptive insulation and a Total Heat Exchanger, THEX, see Figure 3.5.1. The lightweight concrete with nano-additives acts as efficient thermal storage and as load bearing structure (Cordis 2015). All the integrated components are attached to the lightweight concrete (Lacave et.al 2015). The lightweight concrete has a density of 1 600 kg/m³ and has a twice as high specific heat coefficient compared to a traditional concrete with a density of 2 400 kg/m³ (Adaptiwall 2015).

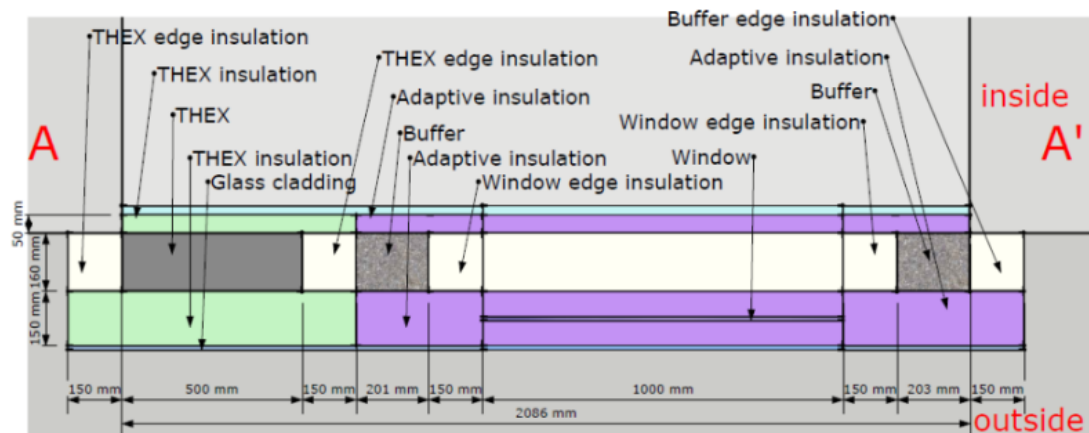

Figure 3.5.1: The components integrated in the Adaptiwall (Adaptiwall 2016).

The adaptable insulation acts as a switchable thermal resistor where a microcontroller device is connected to a sensor to regulate the adaptive insulation according to the indoor comfort needs. The THEX with nanostructured membrane has an efficiency of >75 % and is integrated for temperature, humidity and anti-bacterial control (Cordis 2015).

3.6 Façade system 6 – MeeFS Retrofitting

MeeFS Retrofitting stands for multi-functional energy-efficient façade system for building retrofitting. The aim of the MeeFS project is to develop, evaluate and demonstrate an innovative multi-functional façade system to improve the energy-efficiency of retrofitting. The project focuses on retrofitting residential buildings in Europe (MeeFS I 2016).

The MeeFS façade system consists of multi-functional panels, which consists of a technological module and a structural panel, see Figure 3.6.1. The structural panels will be made out of lightweight composite materials, such as Fibre Reinforced Polymer (FRP). The structural panels will be hollow to simplify connections with existing and integrated installations, and will at the bottom be fixed to the slabs of the existing building (MeeFS I 2016).

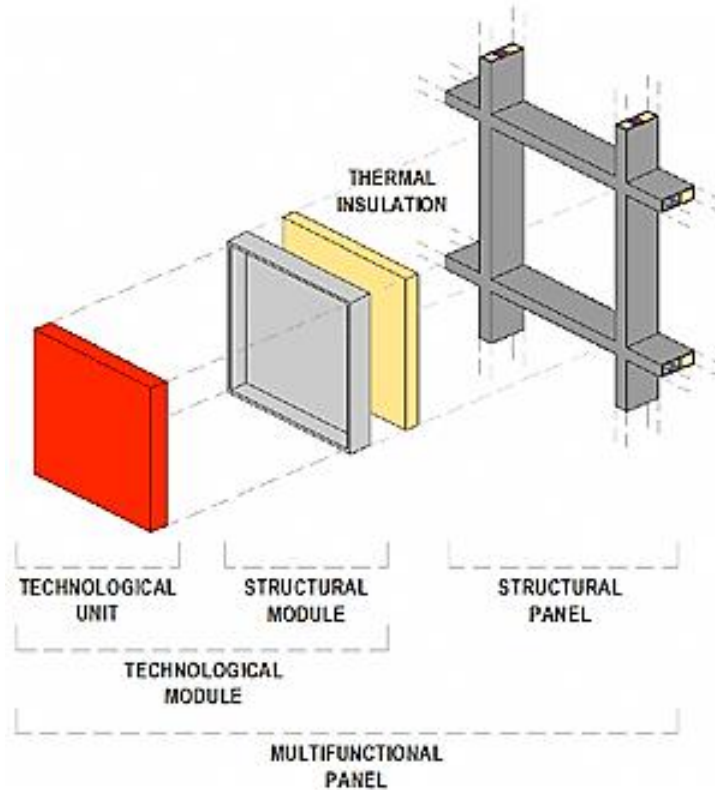

Figure 3.6.1: MeeFS Retrofitting multi-functional panel (MeeFS 2016).

The technological module consists of a technological unit and a structural module. The technological modules can be opaque or transparent (e.g. windows). The opaque modules consist of thermal insulation and a technological unit. The technological modules will be made out of composite materials, and easy to manufacture and be flexible, lightweight and profitable. There are different types of technological units that can be fitted in the technological module. For example: Glazing technological unit, Solar protection technological unit, Solar thermal technological unit and Green façade technological unit, presented in Figure 3.6.2 (MeeFS II 2016).

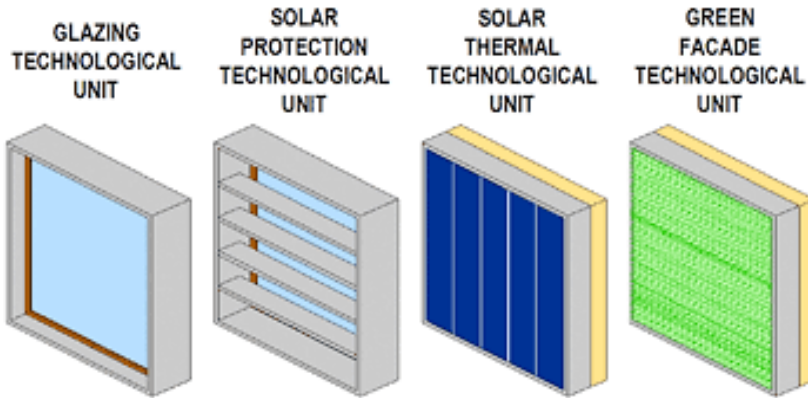

Figure 3.6.2: Examples of different types of technological units which can be integrated into the module (MeeFS 2016).

There are two new multi-functional units that can be integrated: *Advanced passive solar protector & energy absorption unit* and *Advanced passive solar collector & ventilation unit*. The first mentioned is a unit where different passive strategies are integrated within the same technological unit. It will consist of rows of horizontal rotating slats, which will be multi-functional as they are made of two different materials and selective coatings. The slats' purpose is to adapt to the climatic conditions with installed sensors which modifies the slats' position, see Figure 3.6.3 (MeeFS II 2016).

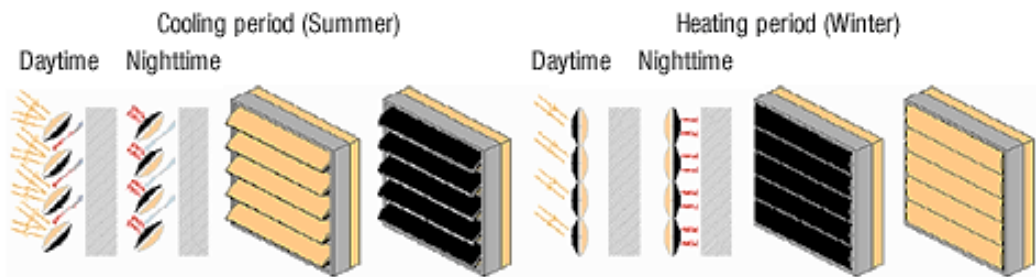

Figure 3.6.3: How the slats position varies at day time and night time during cooling and heating periods (MeeFS 2016).

The *Advanced passive solar collector & ventilation unit* consists of a semi-transparent external layer, a lightweight internal wall with high specific heat capacity, an air circulation space between the internal wall and the external layer and at last a controllable cladding system. The controllable cladding system consists of a louver system which controls the airflow pattern in the collector. The louver system's position depends on the climatic conditions and it prevents heat losses during the winter periods and overheating during the summer periods (MeeFS II 2016). The two systems are presented in Figure 3.6.4.

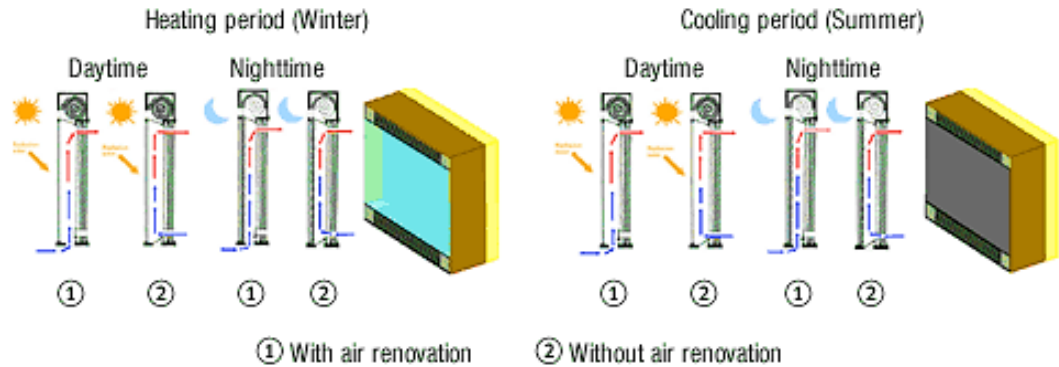

Figure 3.6.4: How the airflow pattern depends on with air renovation (1) or without air renovation (2) and how the cladding system varies depending on climatic conditions (MeeFS 2016).

The MeeFS façade system will be able to reduce the total energy use by 27 % of buildings in European climate zones. MeeFS retrofitting has performed an analysis comparing the financial impacts of traditional ventilated façade systems and their prefabricated MeeFS-system, which resulted in cost-savings of up to 40 % where the mounting costs of the work on site were assumed. Compared to traditional façade systems, the MeeFS façade system reduces the work time on site by 67 % as well as the disturbance of tenants is low. The MeeFS façade system will be demonstrated in a building in the region Extremadura, Spain. The climate conditions for that region of Spain are with a temperature from $<0^{\circ}\text{C}$ in winter to $>35^{\circ}\text{C}$ in the summer. The MeeFS façade system will be evaluated by monitoring the building before and after the renovation (MeeFS II 2016).

3.7 Façade system 7 – ELEMENTUM eco AB

ELEMENTUM eco AB is a Swedish company specialized on prefabricated wall and roof elements with no organic materials. They manufacture prefabricated façade elements in their own factory in Bollebygd, Sweden, and deliver their solutions according to the clients' request (ELEMENTUM eco 2016). ELEMENTUM eco AB has not developed any multi-active façade system, but is one of the companies involved in the on-going research project developing a multi-active façade system in collaboration with LTH.

ELEMENTUM façade element consists of slotted steel studs with Z cross section. The insulation material is a graphite Expanded Polystyrene, EPS, which results in a moisture safe construction. Both the inside and the outside are covered with a fire safe layer of rock wool board. The ELEMENTUM façade element is presented in Figure 3.7.1. The elements are designed according to the existing building's loading conditions, window size and openings. The windows are already mounted to the prefabricated façade elements at the factory (ELEMENTUM eco 2013).

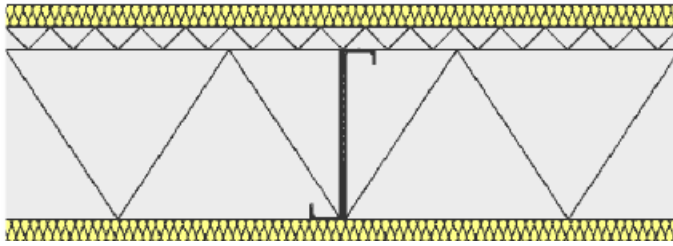

Figure 3.7.1: Prefabricated ELEMENTUM façade element. From top (outside): Rock wool, EPS, EPS and steel studs, rock wool. (ELEMENTUM eco AB 2013)

There is a possibility to apply a ventilated façade layer to the prefabricated element at the factory. The cladding is applied on site after the façade element integration. If the façade elements are not integrated to an existing façade, an internal installation layer and gypsum boards are applied afterwards (ELEMENTUM eco 2013).

3.7.1 Reference project – Renovation of Brogården, Alingsås

The multi-family buildings in Brogården, Alingsås were built in 1971-1973 during the million program period. AB Alingsåshem owns the buildings in Brogården and was collaborating with Skanska AB and other smaller entrepreneurs during the renovation, which started in 2007. The project's objective was to renovate the buildings into passive house standard. The first buildings were renovated with façade elements, which were built on site. This was, however, considered to change for the other stages during the project, where ELEMENTUM eco AB manufactured and delivered their façade elements (Martinsson 2014). The building design before the renovation is presented in Figure 3.7.1.1.



Figure 3.7.1.1: Before the renovation with ELEMENTUM eco elements (Skanska 2014).

The façades were in poor condition, so the infill walls were removed leaving only the bookcase structure of concrete, which is described in Subchapter 1.1. This extensive renovation required an evacuation of the tenants. The elements were mounted vertically to the existing building, except on the end walls where the façade elements were mounted as

additional insulation on the existing concrete wall. The windows were not integrated to the prefabricated façade elements, in this project (Martinsson 2014). How the elements were integrated on site for stage one is presented in Figure 3.7.1.2 and stage three is presented in Figure 3.7.1.3.



Figure 3.7.1.2: Mounting of the built on site ELEMENTUM façade elements at Brogårdén, stage one (Skanska 2014).



Figure 3.7.1.3: Mounting of the prefabricated ELEMENTUM façade elements at Brogårdén, stage three (Skanska 2014).

There was no additional weight on the existing framework since the façade elements weight was carried down to the ground slab. The eave had to be expanded to cover the additional façade layers. The old balconies were built in, which became a part of the living room and new balconies were built outside the new façade. After the façade integration, the elements were sealed to make the buildings airtight. The last step was to mount the windows with U-values between 0.8-0.9 $W/(m^2 \cdot K)$ and the external cladding of yellow thin bricks (Martinsson 2014). The final result of the renovation of Brogården is presented in Figure 3.7.1.4.



Figure 3.7.1.4: The final result of the renovation of Brogården. (Skanska 2014)

The façade construction for stage three has a U-value of approximately 0.10 $W/(m^2 \cdot K)$ and previous thermal bridges are reduced. The U-values for different buildings components for stage one is presented in Table 3.7.1.1. (Martinsson 2014)

Table 3.7.1.1: U-values of building components before and after the renovation for stage one of project Brogården. (AB Alingsåshem 2014)

Building components	U-value before renovation/ $(W/(m^2 \cdot K))$	U-value after renovation/ $(W/(m^2 \cdot K))$
External wall	0.4	0.11
Windows	2.0	0.85
Roof	0.3	0.10
Ground slab	0.5	0.26

The project was successful since the buildings in Brogården reached the objective of passive house standard. The energy use before and after the renovation of stage one and three are presented in Table 3.7.1.2. Lessons learned from this project were that prefabricated façade elements can be used in renovation projects and fulfil the same requirements as for a built on site projects. Furthermore, the prefabrication led to cost-savings in term of time-saving in the construction phase, less amount of material waste and better work environment at the construction site (Martinsson 2014).

Table 3.7.1.2: Measured energy use before and after the renovation at Brogården. (AB Alingsåshem and Alingsås energy 2014)

Annual energy use	Before renovation/ (kWh/m²)	After renovation for stage one/ (kWh/m²)	After renovation for stage three³/ (kWh/m²)
Heating	115	27	19
DHW	42	25	18
Household electricity	39	27	21
Building electricity	20	13	28
Total energy use	216	92	86

³ Svensson Pär. Project manager at Passivhuscentrum. Reference group meeting, 31 March 2016.

4 Methodology

To be able to compare the different multi-active façade systems with the traditional renovation measures, a typically million program house was chosen as a reference house. The site, construction and current status of the reference house are presented in this chapter. The chapter also explains how the comparison between the multi-active façade systems and traditional renovation measures were performed and which software tools that were used to calculate the energy use and the LCC of all cases.

4.1 Reference house

The investigated residential area is located in Landskrona, Sweden, and consists of three three-storey buildings with basement and two seven-storey buildings with basement. The residential area is presented in Figure 4.1.1, which shows that there is a high accessibility to the buildings, so the possibility to integrate prefabricated elements should be manageable.

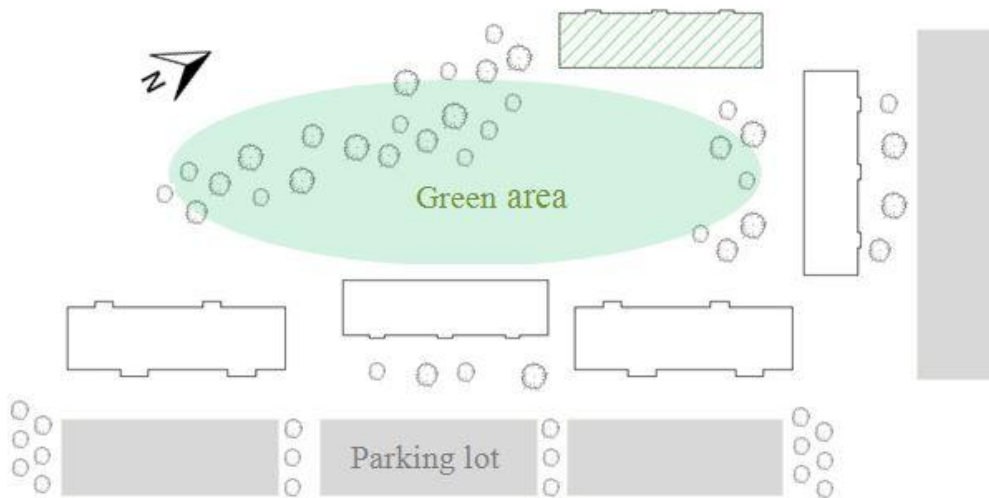

Figure 4.1.1: Residential area, where the investigated reference house is patterned.

The investigated reference house is one of the three-storey buildings, which is a typical Swedish million program house. The building consists of 18 three-room apartments, owned by the municipal property management Landskronahem.

The reference house has a bookcase structure where the structural element of the building is made out of concrete, while the façades consist of lightweight concrete and masonry bricks. The current condition of the masonry bricks is quite good since there are no signs of frost damages. The external infill wall located by the balcony consists of fiber board and wooden studs and a possible thin layer of insulation. But throughout the years, there is a large possibility that the insulation has deteriorated and gathered in the bottom of the wall. The attic of the building is a small space between the upper concrete joist and the outer roof

where 100 mm of loose wool is applied. The pictures of the reference house, which were photographed on site, are presented in Figure 4.1.2 - Figure 4.1.4.



Figure 4.1.2: The southeast oriented façade of the reference house.



Figure 4.1.3: The northwest oriented façade of the reference house.



Figure 4.1.4: The end wall and northwest oriented façade of the reference house.

The current ventilation system is a mechanical exhaust air system without heat recovery, where the exhaust air terminals are located in the bathroom and kitchen in each apartment. The supply air enters through air leakages through the façade and vents, which are located beneath the windows, see Figure 4.1.4. The bathrooms are recently renovated in each apartment. The energy declaration which was received from Landskronahem, indicates that the space heating demand and building electricity use was 147 kWh/m² during 2009. The building is heated by radiators which are connected to the local district heating supplier. The current rent for each apartment is 6 380 SEK/month⁴, where the cost for space heating and DHW, as well as the cost for the building electricity, are included in the rent. The household electricity, however, is excluded since the tenants have their own contracts with electricity suppliers.

4.1.1 Building components

A closer investigation of the existing construction of the reference house was a necessity to be able to perform this master's thesis. The energy calculations were based on the floor plan of the reference house, which is presented in Figure 4.1.1.1. The heated floor area of the building was measured to 2143.6 m² including the basement, where the area of one apartment approximately is 80 m².

⁴ Johan Zellbi, Project manager at Landskrona. Email conversation, 22 April 2016.

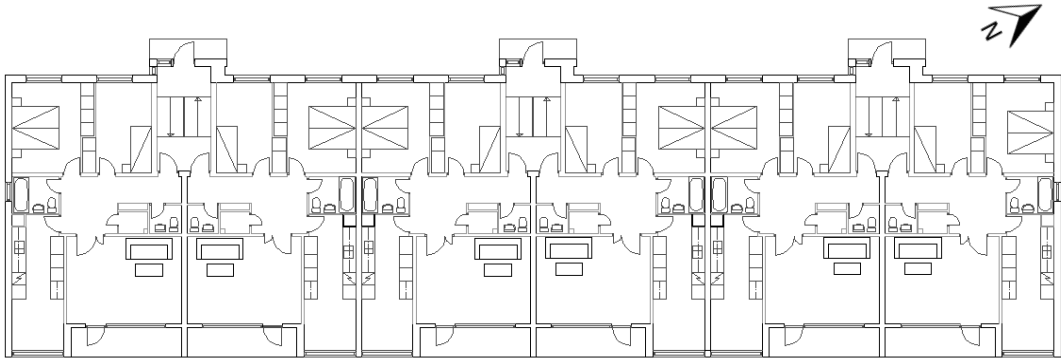

Figure 4.1.1.1: Floor plan of the reference house.

Detailed information about the construction of the reference house, such as component drawings of the walls and roof construction, is not documented. Since no documented construction drawings exist, the construction has been estimated with the staff in the field at WSP group and by visiting the reference house. The existing walls were estimated and are presented in Figure 4.1.1.2. More detailed information, like U-values for the different construction parts, is presented in Subchapter 4.4.

End wall:

120 mm masonry bricks + 200 mm lightweight concrete

Long side wall:

120 mm masonry bricks + 40 mm insulation + 150 mm lightweight concrete

Infill wall:

12 mm fibreboard + 75 mm wooden joist with insulation + 13 mm gypsum board

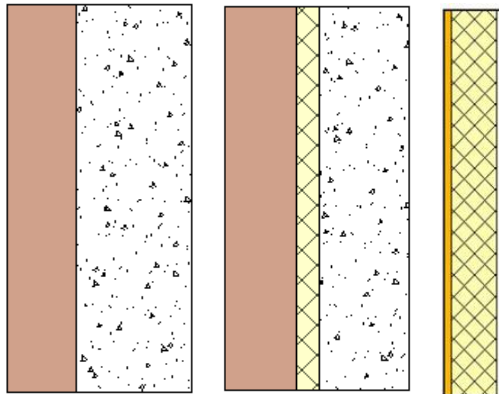

Figure 4.1.1.2: Details of the different wall constructions located in the building. (Left) End wall (Middle) Long side wall (Right) Infill wall.

4.2 Traditional renovation measures vs. multi-active façade systems

To determine if multi-active façade systems are more energy-efficient than traditional renovation measures, a comparison between three different multi-active façade systems and

traditional renovation measures mounted separately were performed. The traditional renovation measures were decided to be similar to the multi-active façade solutions, e.g. considering the thickness of the added insulation, so that the cases could be comparable. The traditional renovation measures are:

- 180 mm additional exterior façade insulation of rock wool with a heat conductivity of $0.035 \text{ W}/(\text{m}^2\cdot\text{K})$
- New windows with a U-value of $0.8 \text{ W}/(\text{m}^2\cdot\text{K})$ and new balcony doors with a U-value of $1.1 \text{ W}/(\text{m}^2\cdot\text{K})$
- 400 mm new loose wool in the attic with a heat conductivity of $0.042 \text{ W}/(\text{m}^2\cdot\text{K})$
- Balanced ventilation system with heat recovery, with an efficiency of 85 %.

To be able to perform further investigations of different multi-active façade systems, they had to contain some of the renovation measures that are usually performed in the traditional renovation of a multi-family building. If the multi-active façade system did not have integrated ventilation ducts in the façade, the ventilation ducts were integrated separately inside the building. The further investigated multi-active façade systems are:

- GAP:skin
- SmartTES
- Smartfront

The prefabricated GAP³ Solutions was chosen because of its active insulation and because it has been integrated in several renovation projects. GAP³ Solutions was developed and investigated in Austria and has been on the market for 15 years, which indicates that they have a well working system. Their multi-active façade system has a high possibility to perform in a similar way in at least the south part of Sweden, where the climate is similar. GAP³ solutions' GAP:skin with an active honeycomb insulation and windows with a U-value of $0.8 \text{ W}/(\text{m}^2\cdot\text{K})$ were analysed. The other renovation measures such as the balanced ventilation system and new loose wool in the attic were added separately.

The SmartTES façade element is developed and investigated in Austria, which became one of the reasons why it was chosen. SmartTES was also chosen because it is a prefabricated multi-active façade system with integrated ventilation ducts and to be compared with Smartfront which has a similar function but is built on site. Windows with U-value of $0.8 \text{ W}/(\text{m}^2\cdot\text{K})$ and supply air ducts were integrated in the element. New supply air devices were installed and the existing exhaust air ducts were supplemented and connected to the new AHU on the roof. New loose wool was applied separately in the attic.

Smartfront was chosen because it is a Swedish system, which is compared to the other two investigated multi-active façade systems, built on site. Smartfront consist of applying 180 mm insulation to the existing walls, new windows with a U-value of $0.8 \text{ W}/(\text{m}^2\cdot\text{K})$, new loose wool of 400 mm applied in the attic and supply air ducts integrated in the façade. New supply air terminals were installed and the existing exhaust air ducts were supplemented and connected to the new AHU on the roof.

As mentioned before, the traditional renovation measures were decided to be similar to the multi-active façades. Additional exterior façade insulation of 180 mm rock wool was

selected since two of the three multi-active façade systems have 180 mm insulation in the façade. The windows and balcony doors were selected to fulfil passive house standard. (FEBY12 2012) The efficiency of 85 % of the heat recovery was selected since the heat recovery in Wikell’s database had an efficiency of 85 %. The new loose wool applied in the attic were selected to be 400 mm since Smartfront has performed analyses, which concluded that there must be 400 mm fire safe insulation to ensure minimization of heat loss and risk of fire spread.

4.2.1 Advantages and disadvantages

After studying several existing multi-active façade systems, the authors of this master’s thesis have concluded that there are both advantages and disadvantages by integrating these systems to existing façades. An advantage for a multi-active façade might be a disadvantage for traditional renovation measures. Therefore, a comparison of the advantages and disadvantages between the analysed multi-active façades and traditional renovation measures has been performed, see Table 4.2.1.1. The advantages and disadvantages depend of which multi-active façade system and which traditional renovation measure that is integrated.

Table 4.2.1.1: Comparison of advantages and disadvantages between the analysed multi-active façades and traditional renovation measures.

Advantages	Multi-active façade	Traditional renovation measures
Reduced energy use	X	X
Better indoor quality	X	X
Reduced noise	X	X
Decreased environmental impact	X	X
Better work environment at the construction site	X	
No evacuation of tenants during renovation	X	
Low disturbance for the tenants during renovation	X	
Short construction time	X	
Disadvantages		
Exceeded limited areas in the local plan	X	
The cultural heritage damage	X	
Reduced daylight accessibility	X	X
Noise from ventilation system	X	X
Risk for no proper fit of the prefabricated elements	X	
Renovation classified as reconstruction	X	X
Moisture damage in façade from building services	X	
Space loss		X
No accessibility to the building	X	

The energy use of the buildings is reduced whether the buildings are renovated with multi-active façades or traditional renovation measures, but how much it reduces depends on the insulation thickness or which multi-active façade that is being integrated. By reducing the energy use of a building significantly, the environmental impact reduces as well.

The balanced ventilation system with heat recovery improves the indoor climate of the apartments. The indoor temperature gets more even since no drafts appear and because the supplied air is preheated. Although, the apartments become quieter since the additional insulation stops noise from traffic and other factors, the tenants might hear sound from the ventilation system. Therefore, it is important to follow requirements when dimensioning the ducts and terminals, and a silencer can be necessary to be installed to the supply air terminals to reduce noise. An advantage of integrating supply air ducts in the façade is that it prevents space losses within the apartments.

Another advantage of integrating multi-active façades is that it simplifies the renovation process, since the tenants do not need to be evacuated during the renovation period. The renovation occurs externally with only a few short visits to the apartments, which means that the tenants are less disturbed compared to traditional renovation without evacuation of the tenants. This depends of course on the size of the renovation and which type of building that needs to be renovated. If the renovation is so extensive that it is classified as a reconstruction, there are accessibility regulations which need to be fulfilled. This problem occurs for renovation with both multi-active façade and traditional renovation measures.

A disadvantage for both multi-active façades and traditional renovation measures is that an increased façade volume reduces the daylight accessibility inside the apartment. Additional external insulation can also be a disadvantage due to the expansion of the façade volume. There is a limit in the local plan which the building cannot exceed. This is a disadvantage for multi-active façades, which have their fixed wall thickness, e.g. space for ventilation ducts. The traditional renovation measures, however, can adapt the insulation thickness so that the building areas in the local plan are not exceeded. The cultural heritage must be protected, which means that the architectural design cannot be changed or touched. To renovate the façade externally can therefore be hard to carry through. These buildings can be renovated from the inside, which means this is a disadvantage for multi-active façades.

Integrating water pipes in the façades can be risky. There is a possibility that a pipe break occurs and the water damage can be huge. Therefore, the pipes need to be accessible from the inside or outside. There is also a possibility that the façade element does not match the existing structure, each multi-active façade element can be different since each project is individual. To avoid this, the existing building might be carefully measured by a 3D laser scanning. Although it might be a risk, the prefabricated multi-active façades reduce heavy lifts and time consuming work for the construction workers. This results in a shorter construction time and a better work environment at the construction site. If there is no accessibility for cranes, the integration of the prefabricated multi-active façade elements can be complicated or may not even be possible to perform. During a lift in confined spaces, the elements are most likely to be damaged.

4.3 Software tools

This subchapter gives information about the used software tools and for which purpose they were used for.

4.3.1 IDA ICE

IDA Indoor Climate and Energy 4.6.2, IDA ICE, was used to perform the dynamic building energy simulations and the indoor climate analysis. The software is developed by the Swedish company EQUA simulation AB. The software tool provides e.g. 3D modelling of buildings and zone distribution. The program is validating towards ASHRAE 140, CEN Standard EN 15255 and 15265, and CEN Standard EN 1379 (Equa 2016).

4.3.2 HEAT2

Heat2 was used to calculate the heat transfer through the building envelope and to control the thermal bridges when applying ventilation ducts in the façade. Heat2 is a simulation program in 2D that calculates the transient and steady-state heat transfer. The program is validating towards EN ISO 10211 and EN ISO 10077-2 standard (Heat2 2014).

4.3.3 Wikells' Sektionsdata

Wikells byggberäkningar AB's calculation tool Sektionsdata was used to obtain price information of material, mounting and salary costs for the LCC analysis. Sektionsdata is a software tool with a database containing investment costs for calculations of new buildings, repair, refurbishment and extensions, electrical, water and sanitary and ventilation (Wikells byggberäkningar AB 2016).

4.4 Energy calculations

Before starting the energy simulations for the new façade systems, a base case was created to estimate the current status of the energy use of the reference house. The reference house was modeled in the software IDA ICE. The building constructions and U-values were estimated by analyzing the building at site and by studying how buildings were built during the 1960's (Björk, C, Kallstenius, P & Reppen, L 2013). Input data for internal gains, lighting and other factors were estimated according to the recommendations from SVEBY (2012). The input data for the base case are presented in Table 4.4.1.

Table 4.4.1.: Input data for Base case energy calculation.

IDA ICE Input data for base case		
Building		
Location	Landskrona	
Weather files	Malmö Sturup	
Orientation	30° towards northeast	
Heated floor area/m ²	2143.6	
Construction		
<i>Openings/U-values</i>		
Window/(W/(m ² ·K))	2.90	
Window Bathroom/(W/(m ² ·K))	1.40	
Entrance/(W/(m ² ·K))	1.40	
Celler door/(W/(m ² ·K))	1.00	
<i>Walls/U-values</i>		
End wall/(W/(m ² ·K))	0.59	
Long side wall/(W/(m ² ·K))	0.49	
Infill wall/(W/(m ² ·K))	0.50	
Basement wall/(W/(m ² ·K))	2.89	
<i>Flooring/U-values</i>		
Ground floor	3.48	
<i>Roof/U-values</i>		
External roof/(W/(m ² ·K))	0.37	
Infiltration- Wind driven/(l/(s·m ²))	1	At 50 Pa
Outside area towards air		
Thermal bridges/%	20	Estimated
Ground properties/(W/(m ² ·K))	1.40	
Installation system		Schedules
District heating, heating set point/°C	21.50	Always on
Cooling	No cooling	Always off
Manual Ventilation - open windows when inside temperature above/°C	25	Always on
Ventilation rate exhaust air/(l/(s·m ²))	0.49	Always on
SFP/(kW/(m ³ /s))	2	
DHW/(kWh/m ²)	30	Always on
Internal gains		Schedules
Lightning/(W/m ²)	4.20	8 h/day
Equipment/(W/m ²)	1.42	Always on
Occupants/(person/apt.)	2.18	14 h/(day·person)
Building electricity		
Fans, pumps etc./(kWh/m ²)	14.76	Always on

The base case result was compared to the energy declaration from Landskronahem and the energy calculation performed by WSP group. The base case result was 7 % lower than the energy declaration, which only consisted of space heating demand and building electricity use. WSP performed an energy calculation using the simulation tool VIP-Energy (VIP-

Energy 2016). The two programs calculate differently, which could result in a different calculated energy use. The base case result was 3 % higher than WSP's result, because of different assumptions. The thermal bridges were estimated to 20 % of the total transmission lost, while WSP did not calculate with any thermal bridges. Other data that differed were: room temperature and infiltration rate. The ventilation rate for the exhaust air of 0.49 l/(s·m²) were assumed by WSP group, and were also used in the base case simulation. Even though Landskonahem turns off the radiators during the summer period from June until September, the heat was turned on during the whole year in all the energy simulations.

A parametric study was performed to analyse how each renovation measure affects the energy use of the reference house, see Figure 4.4.1. The parametric study was based on the results from the base case, where each parameter was applied to the base case model.

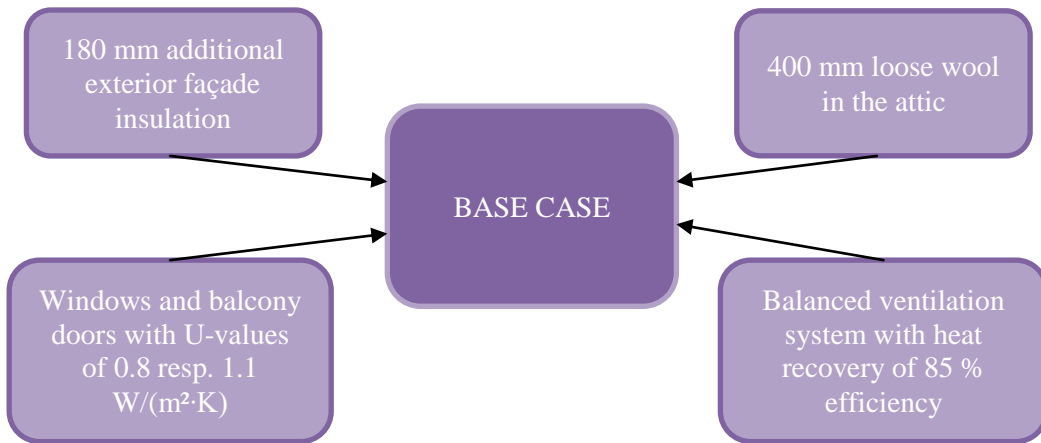

Figure 4.4.1: The parametric study chart.

All parameters in the parametric study were applied simultaneously in the base case model and calculated as the traditional renovation measures. The three different multi-active façade systems were also applied to the base case model.

Each apartment was divided into one zone in the IDA ICE model, see Figure 4.4.2. In this master's thesis, the general advice from the Swedish Public Health Agency was taken into consideration concerning the indoor climate. Their general advices are that the indoor temperature should not drop below 20°C, and the temperature should not exceed 24°C during a longer period. During the summer, the temperature should not exceed 28°C (Social Board 2005). In all the simulations it was assumed that the tenants open the windows when the indoor temperature exceeds 25°C. The indoor air is cleaner because of good filters which can reduce asthma and other diseases caused by poor indoor climate. Good indoor climate provides a better health of the tenants, since it also reduces noise from traffic and other noise (Swedish Public Health Agency 2016). The improved ventilation system was dimensioned according to BBR's (2011) regulations where the inlet air should fulfil 0.35 l/s per m² floor area and 7 l/s per person.

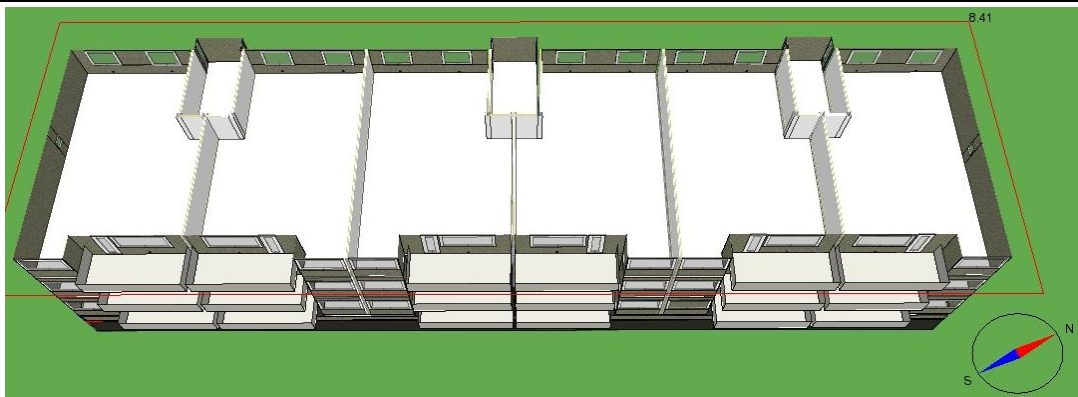

Figure 4.4.2: Apartments and stairways were divided into zones in IDA ICE.

4.4.1 Traditional renovation measures

The energy calculation of the traditional renovation measures was divided into two cases. In the first case, the existing brick wall was demolished and the additional façade insulation with a render as finish was then applied to the wall. Demolishing the bricks is often suggested in these types of project. This case is further on called *Traditional case 1* in this master's thesis. The second case was performed keeping the brick wall untouched, and the insulation was applied outside the brick wall. This was investigated to generate a more comparable case with the multi-active façades. The second case is further on called *Traditional case 2* in this master's thesis.

A balanced ventilation system with heat recovery was installed internally in both cases. The existing exhaust air ducts were sealed with lining hose and the old exhaust air terminals were replaced with new ones. Supply air ducts with terminals were installed in the two bedrooms and in the living room. The shaft was located in each stairway connecting the ducts to the AHU located on the roof. The old balcony railings were replaced with new railings to fit the new design of the building. Additional insulation on the basement walls and new loose wool in the attic were applied.

4.4.2 GAP³ Solutions

The energy calculation of the integration of GAP:skin to the reference house was divided into two cases. What separates the two cases was that the walls inside the glazed balcony were either insulated with additional insulation or kept as their original constructions. The case where the walls were kept in original construction is further on called *GAP:skin case 1*. The second case where the walls were insulated is further on called *GAP:skin case 2*. The purpose of this division was to investigate if additional insulation in this area is a necessity. In both cases, the balcony railings were removed and the balconies were transformed into glazed balconies. GAP:skin was also simulated with new loose wool in the attic, internally installed ventilation system with heat recovery and additional insulation on the basement walls.

As described in Subchapter 3.1, the GAP:skin façade element varies its U-value depending on the solar irradiation. In the energy simulations the worst case scenario was simulated i.e. the highest possible U-value of the façade was used. The energy use of the building could

get lower due to the U-value of the façade facing the sun could get lower during the sunny days. However, this has not been taken into consideration in the energy simulations i.e. the honeycomb has been calculated as inactive.

4.4.3 SmartTES

To manage to integrate the SmartTES elements to the reference house were the balconies needed to be removed. This was necessary so that the prefabricated SmartTES element with supply air ducts could be integrated to the infill wall adjacent to the living room where the supply air is needed. The supply air ducts that were integrated in the SmartTES elements needed to be analysed further. The SmartTES element integrated to the existing walls were analysed in HEAT2 to control the heat loss impact of the ventilation duct in the wall. The wall layers and the placement of the 100x100 mm duct in the insulation layer are presented in the left Figure 4.4.3.1. The air temperature inside the duct was set to 13°C, which will be the lowest possible temperature in the duct furthest away from the AHU. According to SmartTES (2014), the supply air temperature drops approximately 0.1°C/m, when the air travels from the AHU in the duct in the façade. This may occur on the cold winter days, which is the worst case scenario. The HEAT2 calculation showed that the duct only affected the U-value of the wall slightly. Therefore, in the energy calculations, this is not taken into consideration. The wall gets warmer further out in the construction, which comes from the warm air inside the duct and not from the inside of the building. However, the right Figure 4.4.3.1 shows that a thermal bridge appears where the duct penetrates the wall. This heat loss was applied to the energy simulations by placing a higher U-value in every region where the inlet to the supply air was located. The same simulation was performed where the supply air penetrates the infill wall but is not presented in this master's thesis. The U-values of the wall parts were calculated to 1.6 W/(m²·K) for the long side wall and 0.82 W/(m²·K) for the infill wall.

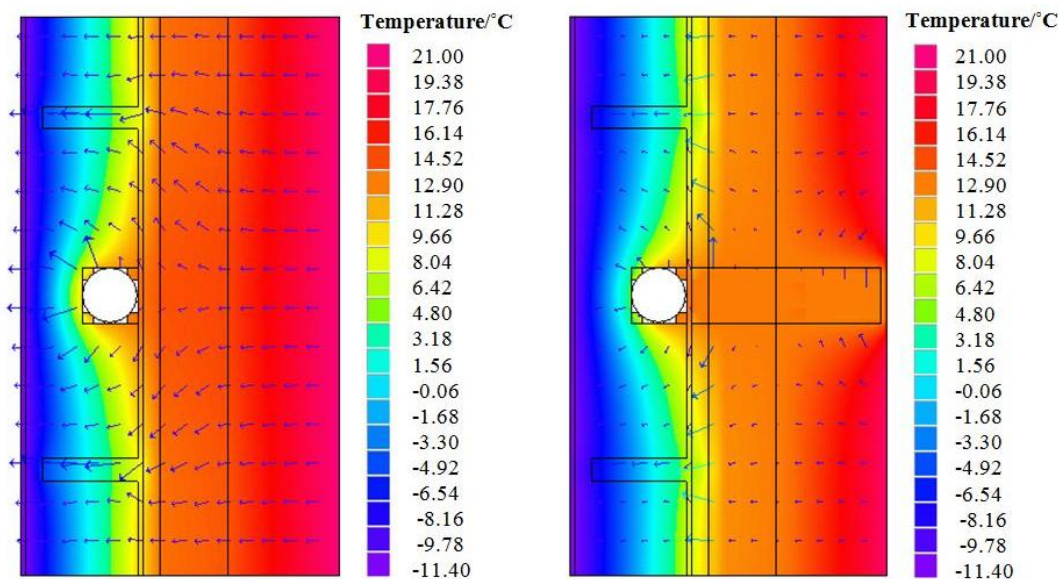

Figure 4.4.3.1: Temperature variation in the SmartTES wall with: (Left) duct 100x100 mm along the wall (Right) duct 100x100 mm penetrating the wall.

The placement of the supply air ducts in the SmartTES element is presented in Figure 4.4.3.2, which is an example of how the SmartTES element could be integrated to the reference house. One supply air duct is mounted for each inlet, which is located above the windows in the apartments. The SmartTES elements with integrated supply air ducts were also integrated to the northwest façade. SmartTES was also simulated with new loose wool in the attic and additional insulation on the basement walls.

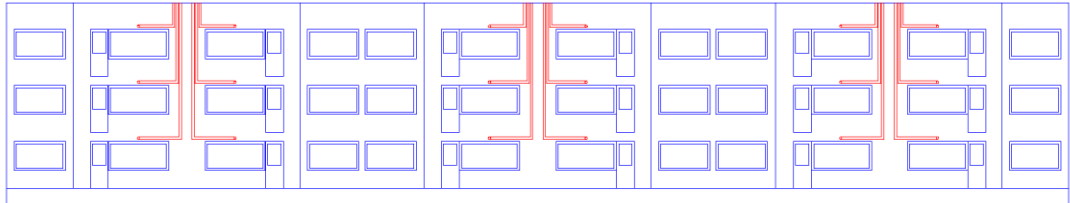

Figure 4.4.3.2: The placement of the ventilation duct in the SmartTES façade oriented towards southeast.

4.4.4 Smartfront

Smartfront was applied to the reference house and the old balcony railings were replaced with new railings to fit the new design of the building. The Smartfront walls were also analysed in HEAT2 to control the heat loss impact of the ventilation ducts in the wall. For a more detailed description of the HEAT2 analysis, see Subchapter 4.4.3. The duct size was set to 80x80 mm, see Figure 4.4.4.1, and according to Stefan Forsberg at Smartfront, they have calculated that the supply air temperature drops approximately 0.1°C/m. The U-values of the wall parts were calculated to 1.72 W/(m²·K) for the long side wall and 0.72 W/(m²·K) for the infill wall.

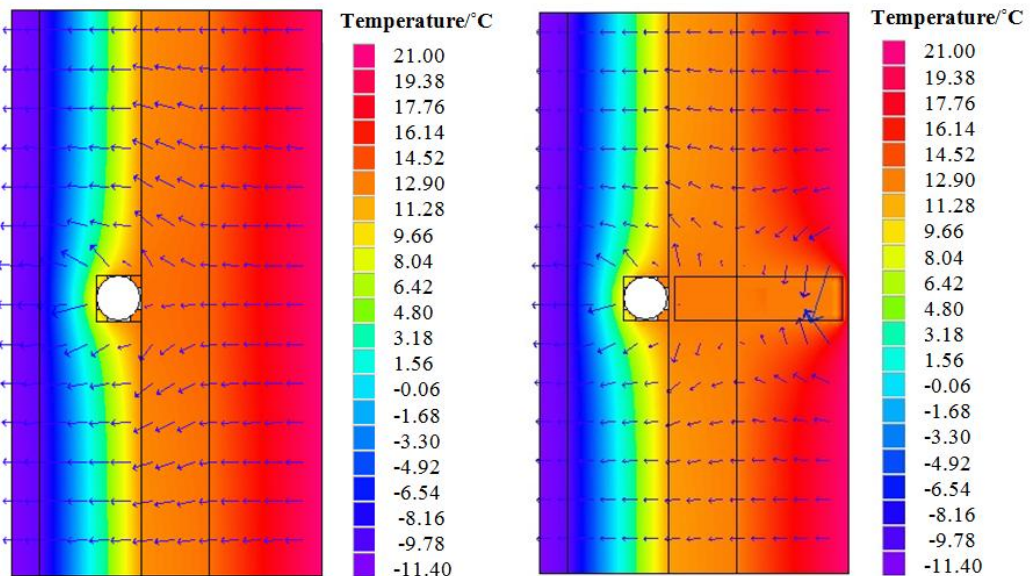

Figure 4.4.4.1: Temperature variation in the Smartfront wall with: (Left) duct 80x80 mm along the wall (Right) duct 80x80 mm penetrating the wall.

The placement of the supply air ducts in the Smartfront wall is presented in Figure 4.4.4.2, which is an example of how Smartfront could be integrated to the reference house. One supply air duct is mounted for each inlet, which is located beneath the windows in the apartments. The supply air ducts were also integrated to the northwest façade.

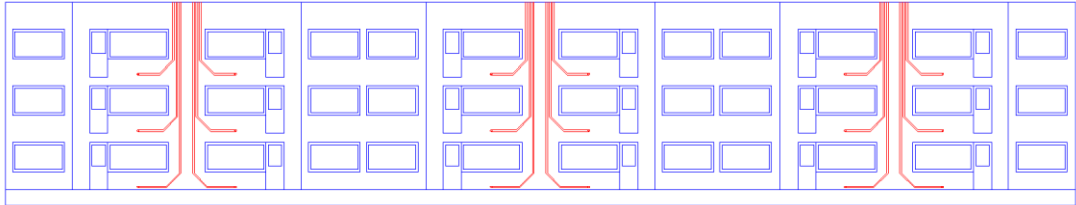

Figure 4.4.4.2: The placement of the ventilation duct in the Smartfront façade, oriented towards southeast.

4.4.5 Input data for energy calculations

The energy calculations for the further investigated cases were complicated since two façade systems had parts of the wall with different U-values. The U-values where the ventilation ducts penetrates the wall, were calculated in HEAT2, see Subchapter 4.4.3 for the HEAT2 calculations. The input data for the different cases are presented in Table 4.4.5.1. The input data that is not mentioned in this table is the same as for the base case presented in Table 4.4.1. In the traditional renovation measures and multi-active façade calculations, the Specific Fan Power, SFP, was set to 1.5 kW/(m³/s), which is normal for a new balanced ventilation system with heat recovery according to Warfvinge & Dahlblom (2012).

Table 4.4.5.1: Input data for the traditional renovation measures and the three further studied multi-active façade systems.

IDA ICE Input data				
Construction	Traditional renovation measures	GAP:skin	SmartTES	Smartfront
Windows U-value/ (W/(m ² ·K))	0.8	0.8	0.8	0.8
Balcony doors U-value/ (W/(m ² ·K))	1.1	1.1	1.1	1.1
End wall with bricks U-value/ (W/(m ² ·K))	0.15	0.14	0.13	0.16
End wall without bricks U- value/(W/(m ² ·K))	0.18	-	-	-
Long side with bricks wall U- value/(W/(m ² ·K))	0.14	0.14	0.13	0.14
Long side without bricks wall U-value/(W/(m ² ·K))	0.14	-	-	-
Long side with penetrating ventilation ducts U-value/ W/(m ² ·K)	-	-	1.6	1.72
Infill wall U-value/ (W/(m ² ·K))	0.14	0.14	0.13	0.14
Infill wall with penetrating ventilation ducts U-value/ (W/(m ² ·K))	-	-	0.82	0.72
Basement wall U-value/ (W/(m ² ·K))	0.18	0.18	0.18	0.18
Infiltration/(l/(s·m ²)) Envelope area towards the air	0.5	0.5	0.5	0.5
Ventilation system				
Ventilation rate supply air/ (l/(s·m ²))	0.46	0.46	0.46	0.46
0.35 l/(s·m ²) + 7 l/(s·person)				
Ventilation rate exhaust air/ (l/(s·m ²))	0.49	0.49	0.49	0.49
SFP/(kW/(m ³ /s))	1.5	1.5	1.5	1.5

4.5 LCC analyses

The LCC analysis was performed by calculating the Net Present Value, NPV, which is a common method. The method combines the initial cost with the running cost of the building during a period of time. The initial cost includes the investment cost for materials, workmanship and the possible evacuation or compensation costs. The running cost includes the yearly cost for district heating usage, building electricity usage and maintenance for the

AHU and filters. Other maintenance costs were excluded in this analysis, since the costs were assumed to be the same for the current building as for the renovated building. The running costs are recalculated to a cost at present day, year zero, which is the time of investment. All costs are added over the entire life span of the system, which in this case is 40 years. The LCC analysis was performed by using the following formulas:

$$\sum LCC = \sum \text{Initial cost} + \sum \text{NPV running costs} \quad [\text{MSEK}] \quad (1)$$

$$\begin{aligned} \sum \text{NPV running cost} = & \text{NPV district heating usage} + \\ & \text{NPV building electricity usage} + \\ & \text{NPV maintenance} \end{aligned} \quad [\text{SEK}] \quad (2)$$

$$\text{NPV energy usage} = A_1 \cdot \left(\frac{1 - (1+g)^N (1+i)^{-N}}{i-g} \right) \quad [\text{SEK}] \quad (3)$$

$$A_1 = P \cdot (1+i)^N \quad [\text{SEK}] \quad (4)$$

$$P = A_1 \cdot (1+i)^{-N} \quad [\text{SEK}] \quad (5)$$

$$\text{NPV saving} = \text{LCC base case} - \text{LCC case (1-7)} \quad [\text{SEK}] \quad (6)$$

$$\text{Rent supplement} = \text{NPV saving} \cdot \left(\frac{i(1+i)^N}{(1+i)^N - 1} \right) / (18 \text{ apt} \cdot 12 \text{ month}) \quad [\text{SEK/month}] \quad (7)$$

The mathematical notations used in the formulas are presented in Subchapter 1.6. The NPV saving was calculated by subtracting the total LCC of the base case by the total LCC of the cases. If the NPV is positive, it is a profitable solution to invest in and if the NPV is negative, a rent supplement was calculated to make the investment profitable. The NPV saving was used to calculate the rent supplement which was assumed to be equally paid every month.

4.5.1 Prerequisites for the LCC analyses

When calculating the total LCC of a building it is essential to use reasonable annual rate of interest, annual energy price changes and calculation time. The prerequisites for the LCC analysis are presented in Table 4.5.1.1. The Swedish national bank's target is to have an inflation rate of 2 % and was therefore chosen in this master's thesis (Sveriges Riksbank 2016). The annual real rate of interest was chosen to 4 %, which Landskronahem AB (2015) estimates according to their annual report. Nevertheless, a sensitivity analysis where the annual real rate of interest varied between 3 to 5 % was performed to analyse how much it impacts the NPV of all cases.

Table 4.5.1.1: Prerequisites for the LCC analysis.

Prerequisites	
Calculation time/years	40
Annual real rate of interest/%	4
Inflation rate/%	2
Annual real district heating price increase/%	2.5
Annual real electricity price increase/%	1.5
Annual real AHU price increase/%	2
Annual real filter price increase/%	2
AHU life time/years	20
Filter life time/years	0.5
<i>District heating prices for LandskronaEnergi</i>	
Jan-Mar + Nov-Dec/(SEK/kWh)	0.49
Apr-May + Sep-Oct/(SEK/kWh)	0.26
Jun-Aug/(SEK/kWh)	0.09
Basic price for subscribed power/(SEK/year)	7 300
Price per subscribed power/(SEK/kW)	618/740 ⁵
<i>Electricity prices for LandskronaEnergi</i>	
Range of electricity price/(SEK/kWh)	0.56-0.79 ⁶

In Sweden there are different prerequisites for the district heating prices depending on the supplier. LandskronaEnergi is the district heating supplier for the reference house and charges for one power part and one energy part. The power part means that the customer pays an annual fee determined by the maximum output per day during November to March, called the subscribed power. The power part also includes a basic price depending on the power output. The energy part means that the customer pays a fee per kWh with different fees depending on the season (LandskronaEnergi 2016).

⁵ For buildings with subscribed power output of <60 kW is the price 740 SEK/kW without any additional basic price. For buildings with subscribed power output of 61-175 kW is the price 618 SEK/kW with an additional basic price of 7300 SEK/year (LandskronaEnergi 2016).

⁶ The electricity price range varies depending on the month of the year. The electricity price is lowest during the summer and highest during the winter LandskronaEnergi 2016).

The district heating price in Sweden increases according to the statistics produced by Statistics Sweden on behalf of the Swedish Energy Agency, presented in Figure 4.5.1.1. The trend line shows an annual price increase of approximately 2.5 %, which is chosen in this master’s thesis.

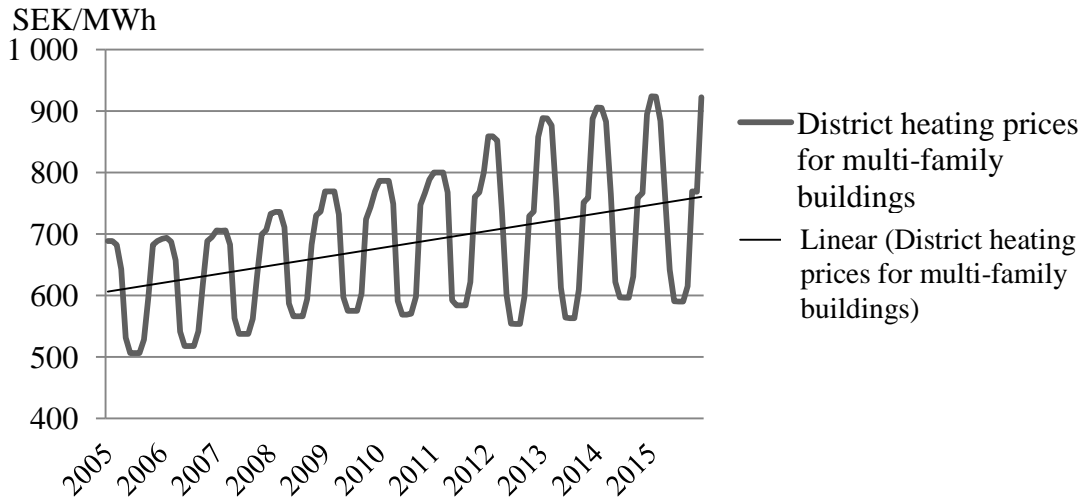

Figure 4.5.1.1: District heating prices (including taxes) from January 2005 to December 2015 (SCB 2015).

The electricity price varies every hour, and every month there is an average price that the electricity companies use. Since the electricity price varies, it is hard to know the exact annual electricity price change. The yearly electricity spot price for the south part of Sweden is presented in Figure 4.5.1.2, where the trend line shows a price increase of approximately 1.5 %, which is used in this master’s thesis.

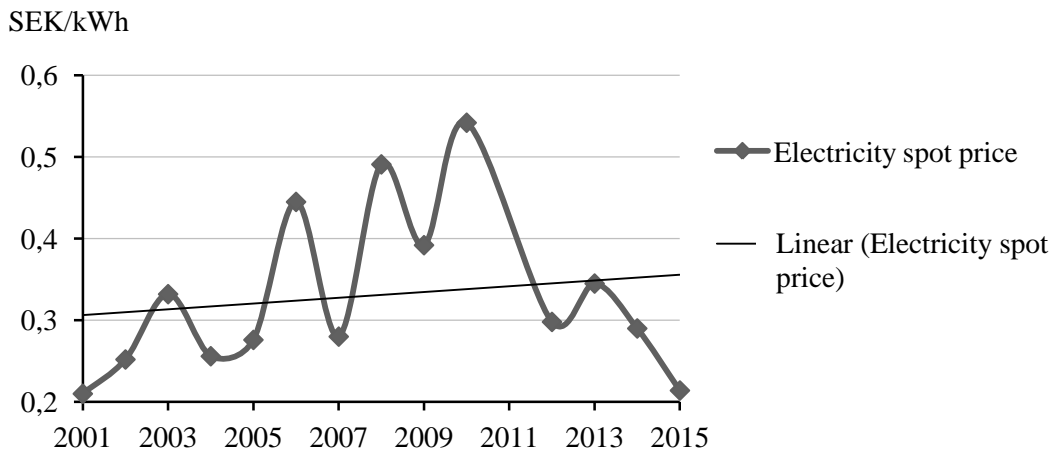

Figure 4.5.1.2: Yearly electricity spot prices according to Nord Pool (2016).

A sensitivity analysis was performed where the annual district heating price increase varied between 0 to 5 %. It was performed to determine how much the price increase affects the NPV of all cases with a calculation time of 40 years and an annual real rate of interest of

4 %. The calculation time of 40 years was chosen because the companies behind the multi-active façade systems believe it is the minimum expected life time of their façade systems. A sensitivity analysis of the calculation time was also performed with the purpose to analyse the calculation time's effect on the NPV. The analysed calculation time varied between 10 to 40 years. Depending on a positive or negative NPV, a rent supplement could be needed. An analysis of the rent supplement as a function of the calculation time was performed, where the analysed calculation times varied between 10 to 40 years. The purpose of the analysis was to determine how much rent supplement is needed depending on how long time the property owner wants to calculate the investment for.

The prices mentioned in this chapter were used in all cases. Prices for the specific cases are presented in the following subchapters, and note that taxes were excluded in all prices in this LCC analysis. The prices for the multi-active façades were obtained from each company in SEK/m² and are approximate and can vary from case to case. The price can vary because of different construction type, accessibility, layout and amount of windows, etc. The price includes both material and mounting costs. The mounting cost is included since there are active components that need to be mounted correctly, which the companies perform to ensure correct functionality of their façades.

Other material costs, mounting costs and workers salary, etc., were obtained by using Sektionsdata. According to Fromell⁷ at Wikells byggberäkningar AB, are the recommended prices in Sektionsdata approximately 6 % higher than the normal purchase price. This also depends on where in Sweden the building is located, since the prices vary between regions. According to Wikells, this 6 % even out the calculation, since it covers the costs for nails and other accessories which are excluded in the calculation.

Windows and balcony doors from Elitfönster (2016) were used in all cases in the LCC analysis and the price of the filters in the AHU was obtained from Ventilationsshopen (2016). According to Sandgren⁸ at Swegon, it is recommended to change filters twice a year, before and after the pollen season. The annual real price increase for filters and AHU were estimated to 2 % and the AHU was calculated to be replaced by a new AHU with the same properties after its life time of 20 years. The price of the sealing of the existing exhaust air ducts was obtained from Högdal (2014), who estimated an approximate price per meter of the lining hose.

4.5.2 Traditional renovation measures

Compared to the energy calculations, the LCC analysis of the traditional renovation measures was divided into three cases. The second case of the energy calculations was divided into two cases, which creates the second and the third case of the LCC analysis.

Since the brick walls were kept in the first case, the tenants could stay during the renovation period. Still, the tenants may experience disturbance during the renovation which needs to be carried out internally, e.g. installation of the balanced ventilation system and the replacement of windows. The tenants normally get compensated for this. In the LCC

⁷ Johan Fromell, Wikells Byggberäkningar AB. Conversation, 12 April 2016.

⁸ Alexander Sandgren, Swegon. Email conversation, 25 April 2016.

analysis, the compensation was a discount of 20 % of the rental fee of one month. This first case is further on called *Traditional case 1*.

In the second case, further on called *Traditional case 2*, were the brick walls demolished. Demolishing the brick walls also demolishes the infill walls and the windows, only leaving the load bearing structure of lightweight concrete. To carry this out the building needs to be evacuated, this cost is included in the LCC for this case. The price for an evacuation varies between projects, but is always expensive. The evacuation price and length was estimated based on recommendations given from Zellbi⁹, project manager at Landskronahem AB and Forsberg¹⁰, project manager at Smartfront. The evacuation apartments were assumed to be available for the tenants, which results in rental losses only during the renovation time of six months.

The third case, however, was assumed to have larger rental losses because evacuation apartments were unavailable. According to Zellbi, Landskronahem AB does not have any currently available apartments with the same standard which can be used as evacuation apartments. Landskronahem AB will therefore be needed to find the amount of apartments that are needed for the evacuation. The tenants have rights to accept or decline what is offered. In this case there were 18 apartments with a rental fee of 6 380 SEK/month. By informing the tenants six months ahead, it was assumed to take two months to find these 18 apartments. In addition, there is a rental loss for each month the renovation is on-going, which was assumed to take six months. After the renovation, the tenants move back into their renovated apartments, which leave the evacuation apartments empty and needed to be rented out again. It was assumed to take one month to get new tenants for these apartments. In total there was a rental loss of nine months in this case where there were no evacuation apartments available. However, these numbers could vary depending on where in the country the house is located. This case is further on called *Traditional case 3*.

Moving tenants in and out of the apartments, including costs for packing and cleaning, were assumed in consultation with Zellbi and Forsberg to a cost of 10 000 SEK/move. Therefore, the total moving costs were assumed to 20 000 SEK/apartment for *Traditional case 2* and *Traditional case 3*. However, these numbers could also vary depending on where in the country the house is located.

The price for scaffolding was included in all cases for the traditional renovation measures. As well as the cost for the clogging of the basement windows, the additional insulation of the basement walls, the eave metal sheet and a balanced ventilation system with heat recovery. The price for these measures was obtained by using Sektionsdata, after a rough estimation of ventilation ducts dimensions using friction charts.

4.5.3 GAP:skin

The price for the GAP:skin element is 4 130 SEK/m², excluding window costs according to Bouteiller-Marin¹¹, engineer at GAP³ Solutions. Demolition and mounting cost for

⁹ Johan Zellbi, Project manager at Landskronahem. Email conversation, 22 April 2016.

¹⁰ Stefan Forsberg, Project manager at Smartfront. Email and telephone conversation, 21 April 2016.

¹¹ Daniel Bouteiller-Marin, Engineer at GAP³ Solutions. Email conversation, 15 March 2016.

windows, however, was assumed to be included in the elements mounting price, because the windows are mounted in the elements at the factory before the integration to the existing building. Costs for planning and designing the elements were assumed to be included in the element price.

Additional costs for this case were: the loose wool in the attic, the internally installed balanced ventilation system with heat recovery, the glazed part of the balcony, the clogging of the basement windows, the additional insulation on the basement walls and the eave metal sheet. These prices were obtained using Sektionsdata after a rough estimation of ventilation ducts dimensions using friction charts. The glazed part of the balconies was obtained from Johab uterumsspecilisten (2016).

The LCC analysis of the integration of the GAP:skin to the existing building were divided into two cases. The objective of this division was to determine if the balcony walls were worth insulating or not. In the first case the existing walls inside the glazed balconies were kept as they are and the windows were replaced. This case is further on called *GAP:skin case 1*. In the second case, further on called *GAP:skin case 2*, the walls inside the glazed balconies were added with exterior insulation and new windows.

4.5.4 SmartTES

Since the development of the SmartTES element is an on-going research project there is no price information available. The price for a basic TES-element, however, is 2 295 SEK/m² excluding window costs according to Lattke¹², project coordinator. Demolition and mounting cost for windows was assumed to be included in the element mounting price, because the windows are mounted in the element at the factory before the integration to the existing building. The price for the supply air ducts and terminals were added to the element costs after dimensioning the ducts using friction loss charts and obtaining the prices from Sektionsdata. Costs for planning and designing the elements were assumed to be included in the element price.

Additional costs for this case were: the loose wool in the attic, the new balcony construction, the clogging of the basement windows, the additional insulation on the basement walls and the eave metal plate. These prices were obtained using Sektionsdata.

4.5.5 Smartfront

Smartfront costs 3 600 SEK/m² according to Forsberg¹³, project manager at Smartfront. This price includes every cost that the system offers; cost for material, mounting, scaffolding and inspection. In Smartfront's price are windows from SP fönster included. After a comparison of window prices between SP fönster and Elitfönster, there was a price difference of 250 000 SEK, where SP fönster were cheaper (SP fönster 2016). To make the different cases comparable, 250 000 SEK were added to the total cost of the Smartfront system.

¹² Frank Lattke, Engineer at Bund Deutscher Architekten. Email conversation, 15 March 2016.

¹³ Stefan Forsberg, Project manager at Smartfront. Email and telephone conversation 22, April 2016

The costs that were not included in Smartfront's price were: the cost of new balcony railings and the clogging of the basement windows and these prices were obtained using Sektionsdata.

5 Results

This chapter explains the results of the energy calculations, indoor climate analysis and the LCC analysis in form of diagrams and tables.

5.1 Energy calculations

The energy use of the Base case was calculated to 167 kWh/(m²·a). The parametric study of the renovation measures showed that changing the exhaust air system into a balanced ventilation system with heat recovery had the largest impact on the total energy use. Additional insulation in the attic had the lowest impact on the total energy use, since the attic area is small compared to the total heated floor area. The parametric study is presented in Figure 5.1.1 Comparing the results of additional insulation applied on the brick wall and on the light weight concrete wall, resulted in a small difference on the total energy use. This means the energy use will not be the main factor of deciding whether to keep or demolish the brick wall.

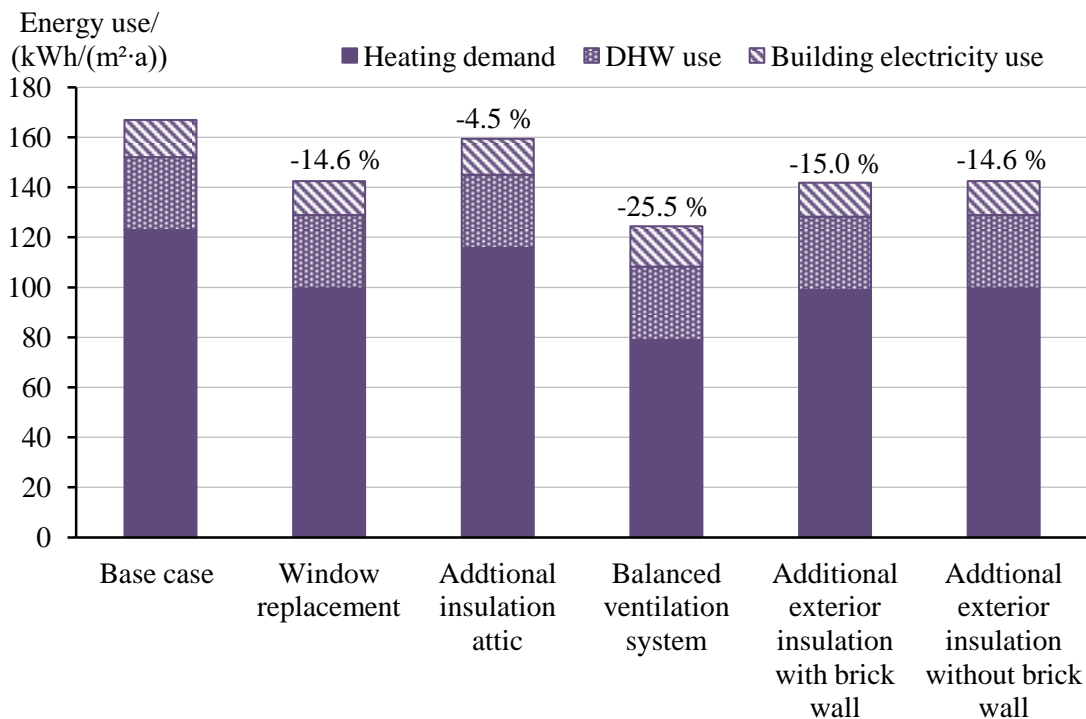

Figure 5.1.1: The renovation measures impact on the energy use compared to the base case.

Adding the reduction of the energy use of each parameter in the parametric study together does not make the result for the cases of the traditional renovation measures. The parametric study only shows the measures individual impact, but when implementing the measures in the same simulation, they impact each other.

A renovation package with all these renovation measures results in a total energy use of 67.8 kWh/m² for the *Traditional case 1* and of 68.2 kWh/m² for the *Traditional case 2*. The energy use of the building with integrated multi-active façade systems became the same as for the traditional renovation measures. The total energy use reduced with approximately 60 % for all cases, see Figure 5.1.2, because the measures in the traditional cases and the multi-active façade systems were alike to be comparable in this master's thesis. BeBo's recommendations for the Reliable Renovations were achieved since the energy use of all cases reduced more than 50 %.

According to Smartfront, their solution reduces the heating demand by at least 50 %, which is clarified in this result where the heating demand reduced by 80 %. The 80 % heating demand reduction applies to all cases. Note that the result for the integration of the GAP:skin was calculated with the honeycomb as inactive, which means that the total energy use for the GAP:skin could be reduced further more. The energy use reduction of *GAP:skin case 1* and *GAP:skin case 2* differed by 0.4 %, which means that the additional insulation of the balcony walls did not impact the energy use significantly.

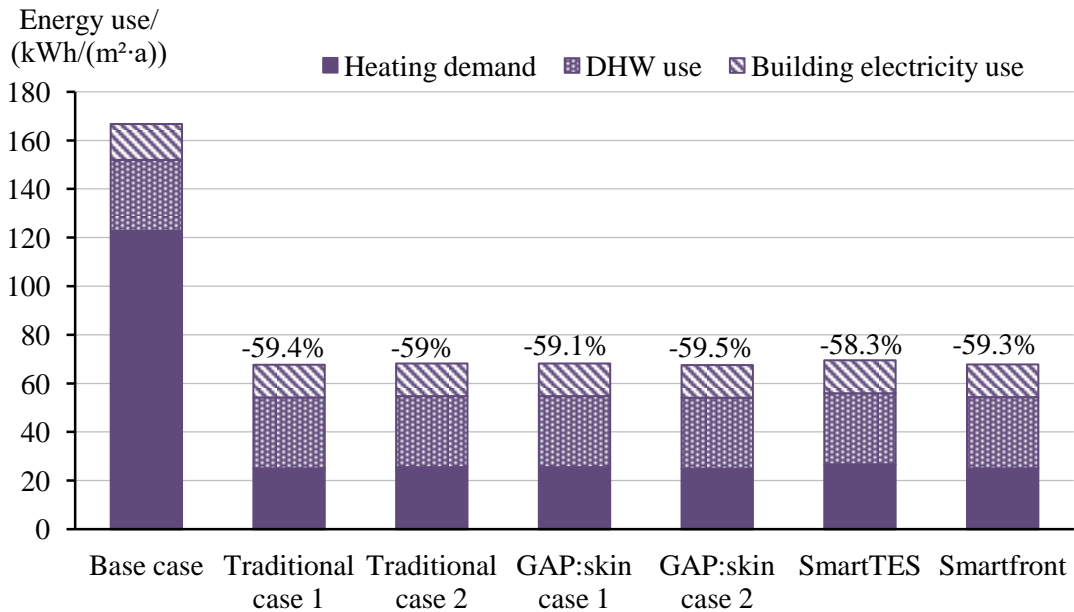

Figure 5.1.2: The energy use of the different systems and their reduction compared to the Base case.

5.1.1 Indoor climate

The calculated operative temperature was collected from the apartment with the most overheating hours, which was the apartment on the top floor in the middle of the building. The operative temperature did not drop below 21°C nor exceed 28°C at any point during the year, which were within the range of general advice from the Swedish Public Health Agency. The maximum operative temperatures occurred during the summer months, see Table 5.1.1.1.

Table 5.1.1.1: The operative temperatures in one apartment.

Operative temperature	Traditional case 1	Traditional case 2	GAP: skin case 1	GAP: skin case 2	Smart TES	Smart front
Minimum/°C	21.6	21.5	21.6	21.6	21.6	21.6
Average/°C	22.8	22.8	22.7	22.7	22.8	22.8
Maximum/°C	27.4	27.5	27.4	27.4	27.4	27.4

5.2 LCC analyses

The LCC analysis was carried out to analyse if integrating a multi-active façade system is more profitable compared to mounting renovation measures separately. The total LCC for each case is presented in Figure 5.2.1, where the solid colours represent initial costs and the patterned colours represent running costs. The initial cost includes costs for materials, workmanship and possible evacuation or compensation costs. The red line represents the break-even point for the different systems, and when the LCC exceeds the red line the investment is not profitable.

The LCC for the base case, calculated for a 40 year period, are more than 5.5 million SEK, which means the cost for keeping the building running in its current status is high. If the property owner chooses to invest another 1.5 million, the property owner gets the building renovated with *Traditional case 1* and Smartfront. The LCC of the case where only the old windows were replaced with new energy-efficient windows was the same as for *Traditional case 1* and Smartfront, which means that in this LCC analysis, only changing windows is not a profitable measure.

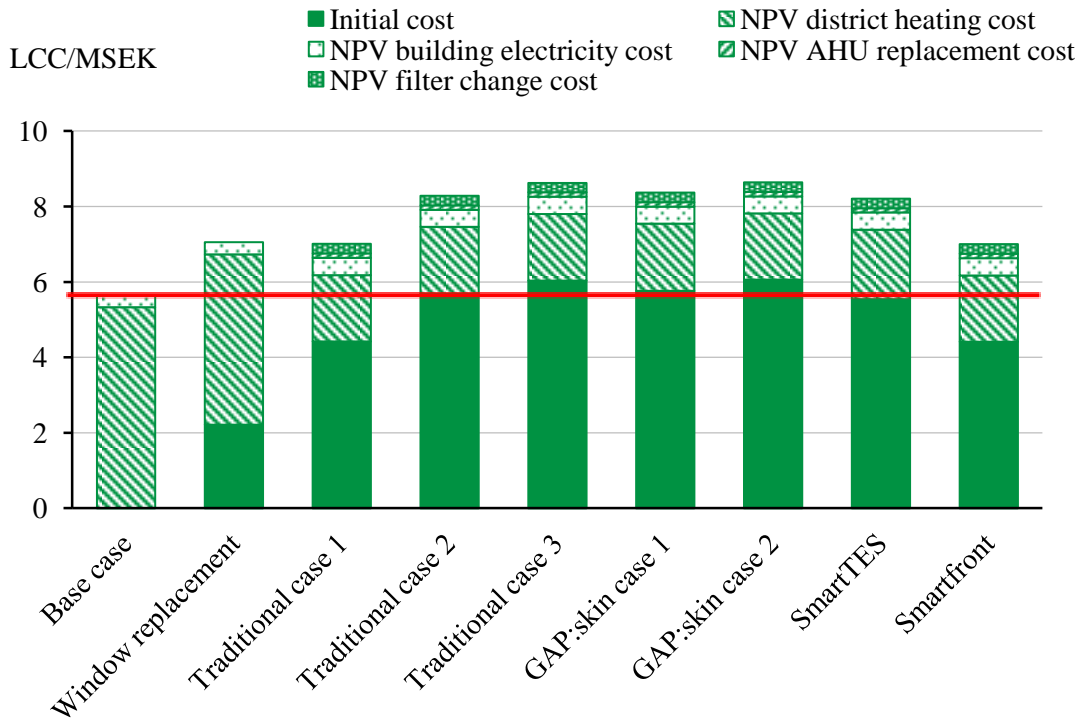

Figure 5.2.1: Initial and running costs in MSEK, for the different cases with a calculation time of 40 years and an annual real rate of interest of 4 %.

SmartTES got more expensive than Smartfront despite their similar functions. SmartTES is expensive to integrate to the reference house due to its high initial cost, since the balconies needed to be demolished and replaced with new ones. Integrating a prefabricated element with integrated supply air ducts is not the optimal solution for this reference house with this type of floor plan.

Comparing the three cases of traditional renovation measures shows that the cost for evacuating the tenants is high. The cost of evacuation is still expensive whether the property owner has empty evacuation apartments available or not. Keeping the brick wall was found to be the most profitable solution. The total LCC of the multi-active façade systems showed a small difference compared to the total LCC of the traditional renovation measures with need of evacuating (*Traditional case 2* and *Traditional case 3*). If evacuation can be prevented, the traditional renovation measures are a better solution than integrating the prefabricated multi-active façade systems. Smartfront is the only multi-active façade system which has the same LCC as the *Traditional case 1*.

The result of *GAP:skin case 1* compared to *GAP:skin case 2*, shows that it is not profitable to apply the additional exterior insulation to the balcony walls. The material cost of insulation is more expensive than the energy that could be saved by adding it. The *GAP:skin* cases, however, could have less running costs since the honeycomb was calculated as inactive.

The red coloured line in Figure 5.2.1 represents the red coloured x-axis in Figure 5.2.2. Positive NPV means that the case is profitable to perform and the energy-efficient measures pay themselves off. The results show that neither traditional measures nor multi-active façade systems are profitable to perform, with a calculation time of 40 years. A high annual real rate of interest resulted in less profitable solution, because the initial cost for the cases does not depend on the annual real rate of interest. The running cost, however, do. High annual real rate of interest reduces the running costs. The NPV saving is obtained by subtracting the total LCC of traditional renovation measures and multi-active façades with the total LCC of the base case. Since the initial cost does not change, the difference increases between the base case and the other cases. The lower the annual real rate of interest is, the more profitable the cases become, and there is always an annual real rate of interest which can make a project profitable. As mentioned before, Landskronahem is using a real rate of interest of 4 %, which therefore is used in the following analyses.

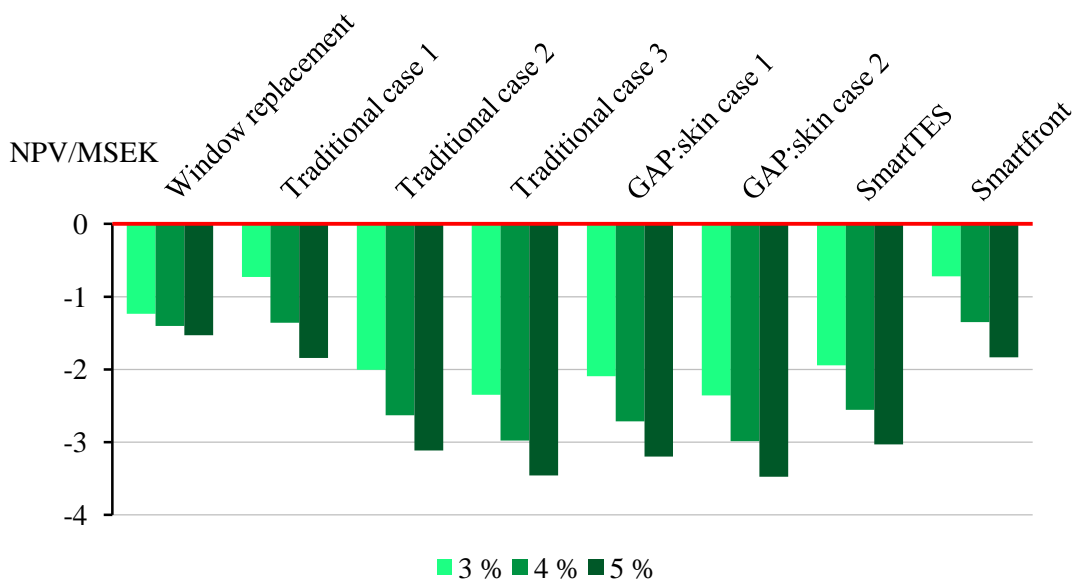

Figure 5.2.2: Sensitivity analysis of the NPV in MSEK with varied annual real rates of interest.

Another sensitivity analysis was performed where the NPV saving in MSEK were analysed as a function of the annual district heating price change, presented in Figure 5.2.3. The analysed annual district heating price change varied between 0 to 5 % at a calculation time of 40 years. With an annual district heating price increase of 5 %, Smartfront and *Traditional case 1* became profitable. The other cases are still not profitable to perform.

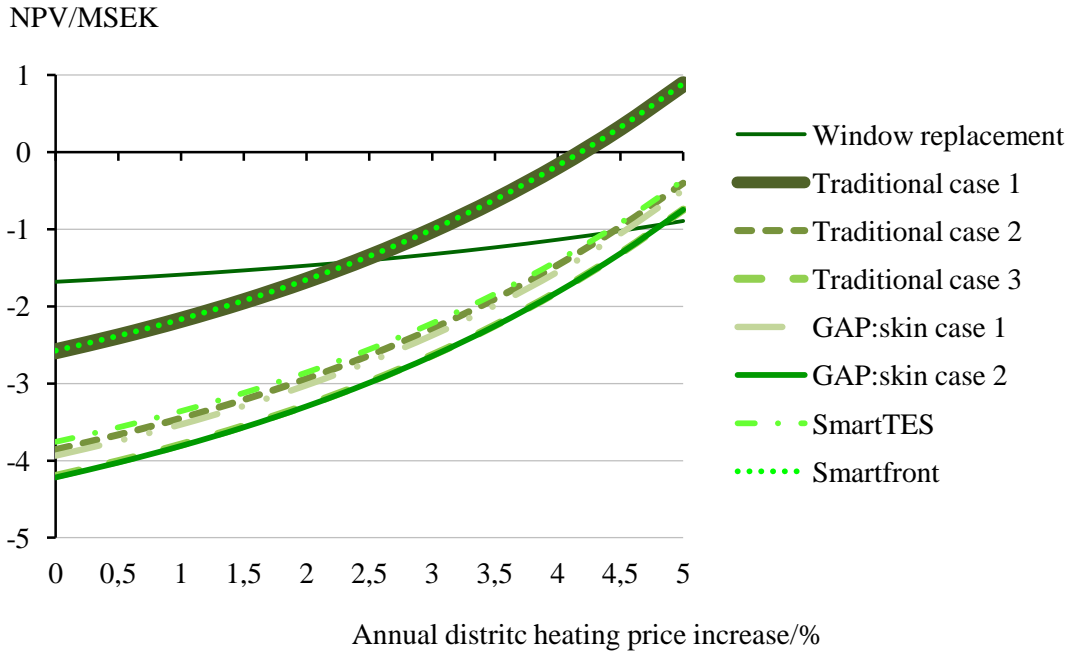

Figure 5.2.3: The profitability in MSEK of the different façade systems at varied price changes.

The results from the NPV saving analysis led to another sensitivity analysis where the calculation time varied, see Figure 5.2.4, which shows how long time it takes for each case to become profitable. *Traditional case 1* and Smartfront have the shortest time to become profitable, which happens when the energy-saving measures pay off. Low running cost will at some point pay the investment cost for the energy-saving measures. For the estimated energy price increase of 2.5 %, it takes 65 years for these systems to become profitable, but for the other cases it takes over 100 years. A rent supplement could be a possible solution to decrease the time to reach the break-even point for the cases.

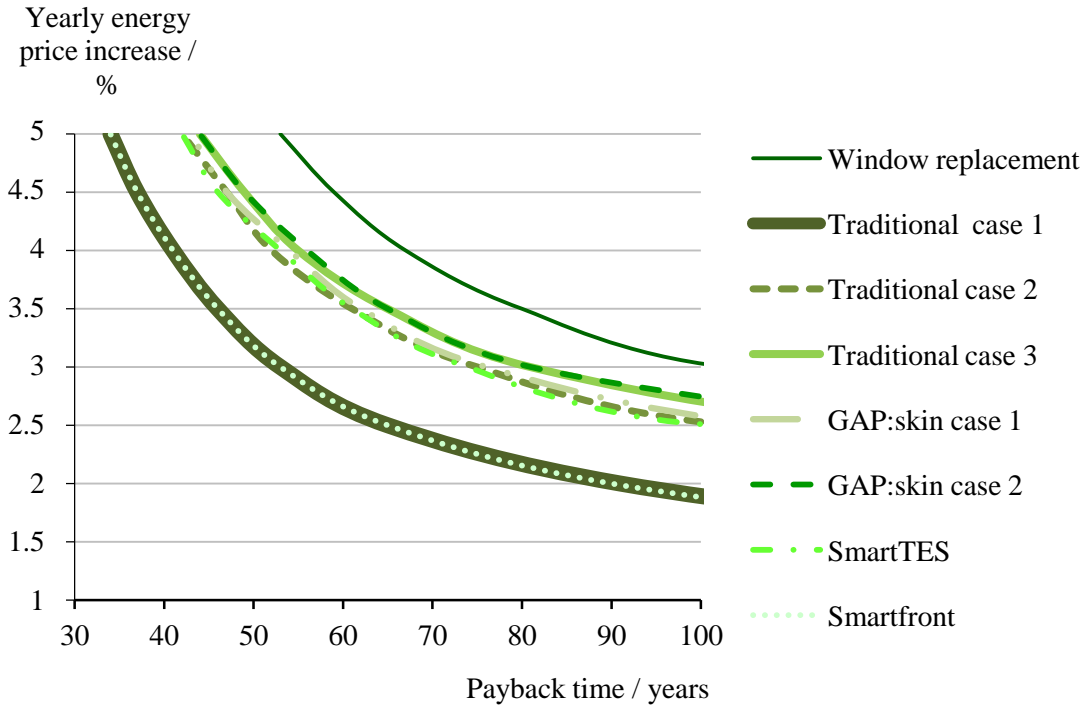

Figure 5.2.4: The annual district heating price increase as a function of the calculation time in years

The rent supplement for each case is presented in Figure 5.2.5, where the rent supplement, in SEK/month, is a function of the calculation time, in years. If the desired calculation time was 40 years, the rent supplement was calculated to be 316 – 699 SEK/month, which equals to 4.9-11.0 % rent supplement for each apartment in the reference house, depending on which case the property owner chooses to carry through. For the traditional cases where evacuation of the tenants was required, the rent supplement over a calculation time of 40 years was more or less the same as by mounting Smartfront with a calculation time of 10 years.

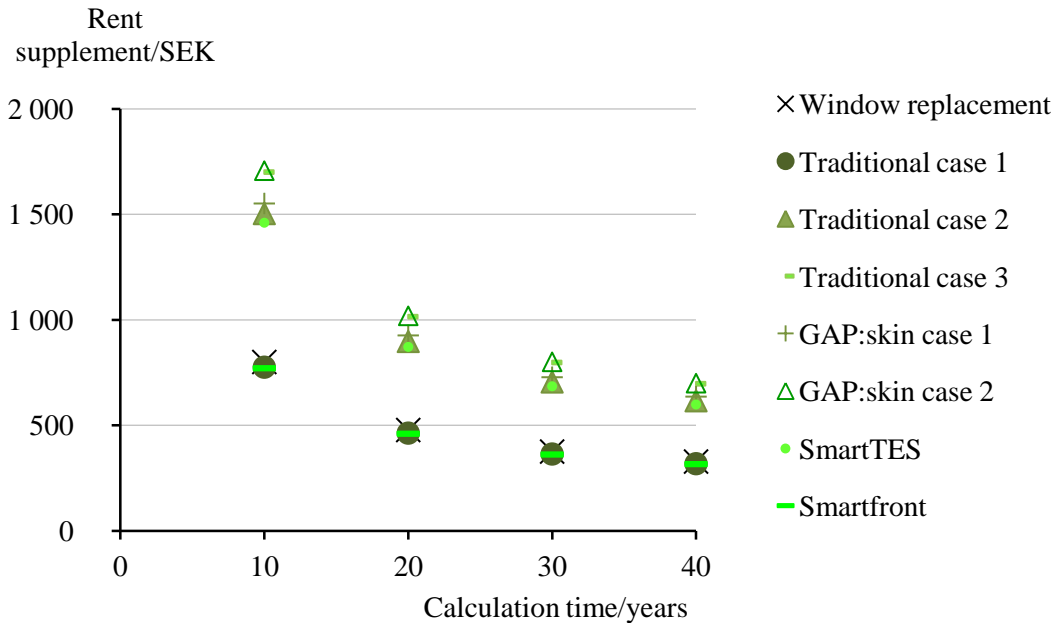

Figure 5.2.5: The rent supplement in SEK/month for the different cases as a function of the payback time in years, with the predicted annual district heating price increase of 2.5 %.

6 Discussion

The investigated reference house was in quite good overall condition. The energy use of the building was high but better than expected. The current condition of the façades was quite good and they were not falling apart. If the status of the façade had been very poor, the situation would have been different and the façade renovation would have been more urgent to perform. However, it is unlikely that the building will be able to perform at its current status in another 40 years. Some kind of renovation cost of the existing building will be necessary at some point during these 40 years, a cost which then could be removed from the investigated multi-active façade systems' investment cost. This would probably make the multi-active façade systems profitable.

The reference house did not have the optimal floor plan for integrating the prefabricated SmartTES elements. It was necessary to demolish the existing balconies to be able to connect the air ducts in the façade to the living room. To integrate the prefabricated SmartTES element in the same way as the GAP:skin façade requires that the construction workers still need to mount the pipes along with the ceiling of the balconies and then through the living room wall. In this situation the SmartTES element loses its purpose, which is why in this case the balconies were demolished and new self-supported balconies were built, which were an expensive measure.

The results show that the GAP:skin element was a rather expensive solution compared to Smartfront and traditional renovation measures. It was not optimal to install a balanced ventilation system with heat recovery when choosing the GAP:skin element because it needs to be installed internally in the apartments, just like the traditional renovation measures. GAP³ Solutions has developed their own device to preheat the outside air before it enters, which probably would have been a more profitable solution. The GAP:skin reduced the energy use of the building as much as the other cases because it was calculated at its worst case scenario. It was calculated with the highest possible U-value, when the honeycomb is inactive, which means it can reduce the energy use more than the other cases. Pilot projects where the GAP:skin has been integrated with similar measures resulted in a space heating reduction of approximately 90 % compared to the space heating reduction of approximately 80 % in this master's thesis. If the honeycomb were calculated as active, the GAP:skin façade system may have turned out profitable.

Disregarding the inactive honeycomb, what separates the different multi-active façade systems the most is not their ability to reduce the energy use. The running cost for the different solutions was more or less the same. The initial cost, however, was the key factor. The prices of the multi-active systems were received in a range indication from the companies. The prices of the multi-active systems can vary depending on the objective of the project, but also the amount of openings, construction type of the existing building and of course what active components are integrated in the façade system. The GAP:skin was more expensive compared to the other façade systems. GAP³ Solutions is the company with the longest experience and with the most number of successful projects. The price includes a more known product compared to the other two multi-active façade systems, which are relatively new and in an on-going phase demonstrating and selling the product.

Overall, the results of the LCC analysis show that it is more profitable to undergo all renovation measures at the same time, instead of just, e.g., changing the windows. This is such an expensive measure for what it generates in energy savings. A building in worse condition than the reference house, where a major renovation is a necessity, the property owner should consider performing all the main renovation measures. Main renovation measures includes: window change, additional insulation, balanced ventilation system with heat recovery.

The advantage of installing the ventilation ducts in the façade is that it reduces construction workers' time inside the apartments. There will not be any interior installations of ducts, which mean there will not be any space losses in the apartment. The energy calculations showed that the balanced ventilation with heat recovery system was the most energy-efficient renovation measure to perform. Therefore, it is important to not avoid this energy-efficient measure, and should be installed either internally or externally depending on what is possible. If the tenants have complaints about installing an internal system, a multi-active façade system is a great solution. Especially Smartfront for this case since Smartfront had the same LCC as the *Traditional case 1*.

The ideal solution would be to renovate a building so it fulfils the low energy requirement, creates a good indoor climate, and at a low investment cost. In reality, one or more of these factors will be affected if one is prioritised. The indoor climate is often forgotten due to the large focus on energy use of the building and the cost of the renovation. Still, performing the renovation measures improves indoor climate. Good indoor climate provides better health for the tenants, since it reduces noise from traffic and other noise. The indoor air is cleaner because of a good filter, which reduces asthma and other diseases. It also reduces drafts which affect the comfort inside the apartment. It should be in everyone's interest to try to improve the public health. A lot of money could be saved in other divisions if everyone lived in buildings with a good indoor climate. From this perspective, the investment of balanced ventilation systems with heat recovery might be allowed to cost some money and the improvement of the indoor climate should result in allowance to raise the rent.

To be able to raise the rent, the utility value of the apartment must be improved. It is a balancing act to decide by how much the property owners are allowed to raise the rent. With a calculation time of 40 years, none of the systems exceeds a rent supplement of 700 SEK/month. The lowest possible rent supplement was 316 SEK/month, which seems like a reasonable supplement for a better indoor climate for the tenants. If the Tenants Association does not allow the rent to be raised, a solution to evade the problem is to perform some internal renovations in the apartments at the same time as façade renovations. The cost of the internal renovations, e.g new kitchen, new flooring, etc., represents a small part of the total cost of the renovation.

The profitability of the renovation depends on the current rent of the apartment. There may be problems when the houses are located in small municipalities where the pressure for apartments is not nearly as big as around the major municipalities. Not all apartments in a building may be rented out if it is located in a small municipality in Sweden, where the long-term plan to finance the renovation in the form of rent supplements for the property owner is less secure. However, right now there is a housing shortage in Sweden and it only seems to be increasing, which could affect the smaller municipalities around Sweden, since

the request of apartments will increase there too. The housing shortage could enhance the profitability of a renovation even in the smaller municipalities in Sweden.

A prefabricated façade element requires more careful planning considering the fitting of the element to the existing building. This critical point applies to both GAP:skin and SmartTES façade systems. The advantage of integrating a prefabricated façade system is that it contributes to a better streamlining of processes and can avoid errors on site. Also, the mounting of the prefabricated elements on site is much faster than mounting the façade systems separately on site. It also requires less heavy work for the construction worker, as the elements are integrated on to the building by a crane. The cost for the short mounting time is added to a higher planning cost at the early phase, which is shown in the results. The main factor which makes the cases built on site cheaper is if the apartments are not needed to be evacuated.

The price for evacuating the buildings can vary depending on many factors, e.g., the size of the project and if the project is divided in different stages. The price can also depend on the sizes of the apartments since the tenants should be offered an evacuation apartment with the same standard as their own apartment. If the evacuation can be avoided, it is the best solution for both the investor, who does not need to pay for it, and the tenants, who do not need to move.

A major problem which arises in the lead-in phase of planning and deciding to undergo a major renovation of a building property is the Swedish regulations concerning the renovations and reconstructions. At this reference house in Landskrona, it would have been a good opportunity to build in the existing balconies with the prefabricated façade elements, and turn the “new” space to lettable area. This would have made the integration of the prefabricated elements simpler. The SmartTES element would have been a good solution, since the demolition of the balconies would not be necessary. Increased floor area would have led to a more profitable solution, since the property owners would have had a reasonable cause to raise the rent. But if these solutions were to be implemented to the building resulting in a larger lettable area, the Swedish regulations require that the apartments should follow the accessibility regulations, i.e. install elevators, and reconstruct the bathrooms. Suddenly the possible profitability disappears. The danger of the regulations of accessibility can lead to the overall condition of the million program houses deteriorating. A solution could be to revise the regulations regarding the million program houses since Sweden has several hundred thousand houses which are constructed in the same way, three storey buildings without elevators. This may lead to more property owners undergoing more extensive energy-efficient renovations which reduce the energy use significantly. In return, this contributes to Sweden reducing the total energy use in the building sector and having a greater possibility to reach the future energy goal of 2050.

7 Conclusions

Multi-active façade systems exist on the market all over Europe. The GAP³ Solutions has been on the market for over 15 years, but there are many façade systems under development. The Swedish company Smartfront has developed a façade system with integrated ventilation ducts in the façade. More people are getting interested in multi-active façades and there is an ongoing growing market for these types of façade solutions.

The multi-active façade systems that are on the market in Europe have integrated active components such as: ventilation ducts, PV-systems, solar thermal collectors, solar control systems, supply air inlets with heat recovery, etc. The potential of integrating different active components in multi-active façade systems is great and makes the systems attractive for many costumers. There are both solutions that are prefabricated elements and those that are built on site.

Multi-active façade systems have the same energy reduction as traditional renovations measures, a reduction of approximately 60 %, and reached BeBo's recommendations. The balanced ventilation system with heat recovery had the highest impact on the energy use, not only for the energy use but also for the indoor climate for the tenants.

A prefabricated multi-active façade system with integrated ventilation ducts was not an optimal solution for this reference house. If the building would have had a different floor plan, the SmartTES façade element could have been more optimal to integrate. However, the integration of multi-active façades reduces the disturbance of the residents during the construction time, when ventilation ducts are integrated in the façade, which means that the built on site façade system Smartfront was a better solution.

To determine if GAP:skin is a profitable multi-active façade system was difficult to establish, because it was difficult to determine the exact U-value of the wall, due to its variation depending on the sun. If the objective is to reduce the energy use and change the building's appearance, the GAP:skin façade is a good solution.

If it is more profitable to renovate a building by integrating multi-active façade systems compared to traditional renovation measures vary from case to case. In this case, it was the same cost to perform traditional renovation measures as to integrate Smartfront, if it is possible to avoid evacuating the tenants. But if not, Smartfront is the most profitable solution. All the multi-active façade system could have been profitable to integrate if the reference house was in poor condition, since the cost can be covered by the maintenance cost, and not as an energy measure. Still, if the property owner could raise the rent with 316 – 699 SEK/month, all the renovation solutions would be profitable to integrate to the reference house in the current condition.

It is important to see energy-efficient renovation measures not only as possibility to earn money, but also as contributing to a sustainable building sector. Renovating a building so it has a low energy use is a way of securing the building's running cost. This is if the future energy prices will increase, or if the government introduces new penalty charges for buildings that exceed the energy use limit.

8 Further studies

The energy prices which were used for calculating the LCC of all cases were obtained from LandskronaEnergi. There is a possibility that the calculated running costs could have turned out differently if the building was connected to another district heating supplier. The prices can vary between the companies supplying district heating in Sweden. It could therefore be interesting to study this problem further.

Integrating a multi-active façade system to an existing building increases the width of the external walls. How much this impacts the daylight factor and daylight autonomy of the apartments could be studied further by performing daylight simulations. Integrated PV-system in the multi-active façade elements may reduce the electricity use of the building. A further study could be to analyse how much the electricity use could be reduced and how the transportation problem could be solved, since the multi-active façade elements become more sensitive with integrated PV-system. The thermal comfort of the apartments could also be studied further, to analyse possible thermal bridges and how tenants experience drafts after integrating multi-active façades.

In the future there is a possibility that there will be regulations regarding the CO₂ emissions of a building. Finding a solution which has low CO₂ emissions can be more important in the future. To perform a Life Cycle Assessment is necessary to find out how the prefabricated multi-active façade elements impact the environment compared to the built on site measures.

Finally, it is important to evaluate the progress of the research projects developing multi-active façades, including the integrated technical solutions and how the pilot projects located in Sweden turns out.

9 Summary

There is a large energy-saving potential in buildings built during the million program period, since they are often poorly insulated and often have a ventilation system without heat recovery. A multi-active façade system can reduce the energy use by approximately 60 % and is as cost-efficient to integrate as traditional renovation measures. The advantage of multi-active facades is that it prevents evacuation of tenants during the renovation period.

Sweden faces an upcoming period where thousands of buildings built during the million program period will be in need of a façade renovation. Performing energy-efficient renovation measures to a building are expensive, which results in that the property owner does not undergo the renovation. This in return can lead to that the façades of the million program houses deteriorate.

A multi-active façade is a wall construction where both passive and active components are integrated. Passive components should fulfill the requirements for thermal, fire and moisture properties. Active components are components which distribute and produce energy, such as ventilation system, heat exchanger, PV-system etc. A thorough market review was performed to determine the quantity of multi-active façades in Europe. Two prefabricated multi-active façade systems, GAP³ Solutions and SmartTES, and one that is built on site, Smartfront, were chosen to perform a deeper investigation of their energy performance and LCC. The analyses were performed by integrating the multi-active façade systems to a typical million program house located in Landskrona, which was used as a reference house. The condition of the façades of the reference house was better than expected, which means they are not in an immediate need of renovation. The multi-active façade systems were compared to both traditional renovation measures and the current status of the reference house.

The multi-active façade systems reduced the energy use of the reference house as much as the traditional renovation measures. The total energy use was reduced by approximately 60 % and the heating demand by approximately 80 %. The most energy-efficient renovation measure to integrate was the balanced ventilation system with heat recovery, which also improved the indoor climate in the apartments. The energy-efficient measures, however, did not pay themselves off in the form of reduced energy use and thus lower running costs. It was found that neither integrating multi-active facade systems nor mounting traditional renovation measures is directly profitable. Profitability can only be achieved when there is a need to renovate the façade and the costs can be covered by the maintenance cost, and not as an energy measure. Smartfront, however, have the same cost over a 40 year period as traditional renovation measures. If the property owner could raise the rent with 316 – 699 SEK/month, all the renovation solutions would be profitable to carry though. The advantages of installing a multi-active façade system contribute to low disturbance for the tenants because of only few visits inside the apartments. Also, the construction time becomes shorter on site and the tenants do not need any compensation.

It is important to see energy- efficient renovation measures not only as possibility to earn money, but also as contributing to a sustainable building sector. Renovating a building so it

has a low energy use is a way of securing the building's running cost. This is if the future energy prices will increase, or if the government introduces new penalty charges for buildings that exceed the energy use limit.

In extensive renovations the Swedish regulations require that the apartments should follow the accessibility regulations, regulations which can be expensive to perform. This contributes to that the property owner avoids renovation of their buildings which can lead to the overall condition of the million program houses deteriorates. A solution could be to revise the regulations regarding the million program houses since Sweden has several hundred thousand houses which are constructed in the same way. This may lead to more property owners undergoing more extensive energy-efficient renovations which reduce the energy use significantly. In return, this contributes to Sweden reducing the total energy use in the building sector and having a greater possibility to reach the future energy goal of 2050.

References

- Adaptiwall (2015). *Second Adaptiwall newsletter*. Available: <http://www.adaptiwall.eu/downloads/#.VqXeueT2bIU> [2016-03-10].
- Adaptiwall I (2016). *Objectives*. Available: <http://www.adaptiwall.eu/articles/objectives/#.VuFEKY-cHIU> [2016-03-10]
- Adaptiwall II (2016). *Background*. Available: <http://www.adaptiwall.eu/mainmenu/background/#.VqXeDeT2bIU> [2016-03-13]
- AEE INTEC. (2010). *Renovation of residential area Dieselweg 3-19 / Graz*. PDF. Available: http://www.nachhaltigwirtschaften.at/iea_pdf/iea_ecbcs_annex_50_anhang7b-demonstration_dieselweg_3-19.pdf [2016-03-09]
- Aschauer, J. (2006). *A new quality of living – Passive house retrofitting of an apartment building*. PDF. GAP Solar. Available: <http://www.aee-intec.at/0uploads/dateien328.pdf> [2016-03-09]
- BBR (2011). *Statutes of Boverket*. BBR 18. BFS 2011:6. p. 57. (Written in Swedish). PDF. Available: <https://rinfo.boverket.se/BBR/PDF/BFS2011-6-BBR18.pdf> [2016-05-02]
- BBR (2015). *Statutes of Boverket. Changes of the regulations in the BFS 2011:6*. BBR 22. BFS 2015:3.(Written in Swedish). PDF. Available: <https://rinfo.boverket.se/BBR/PDF/BFS2015-3-BBR-22.pdf> [2016-05-02]
- BeBo (2016) *What is Reliable Renovations?* (Written in Swedish). Available: <http://www.bebostad.se/rr1-vad-ar-rekorderlig-renovering/> [2016-05-21]
- Björk, C, Kallstenius, P & Reppen, L (2013) *How the houses were built 1880-2000: architecture, construction and materials in our apartment blocks in 120 years* (Written in Swedish). ISBN: 978-91-73-33618-5.
- Boverket I (2014). *One million buildings were built during the million program period*. (Written in Swedish) Available: <http://www.boverket.se/sv/samhallsplanering/stadsutveckling/miljonprogrammet/> [2016-03-03]
- Boverket II (2014). *Pilot study- reconstruction and other changes in Plan and Building Law*. (written in Swedish). PDF. Available: <http://www.boverket.se/contentassets/223380aa0a7540f994136add0e420bf7/forstudie-ombyggnad-andra-andringar-pbl-kunskapsbanken.pdf> [2016-04-06]

Boverket III (2014). *Accommodation influence for tenants during renovation. Edition 1.* (Written in Swedish). PDF. Available: http://www.boverket.se/contentassets/221bdc71a81a4dafbc00cf731f01711e/boendeinflytande_faktablad.pdf [2016-04-19]

Cordis (2015). *Periodic Report Summary 1 - Multi-functional light-weight WALL panel based on ADAPTive Insulation and nanomaterials for energy efficient buildings.* Available: <http://cordis.europa.eu/docs/results/608/608808/periodic1-publishable-summary-adaptiwall-month-18.pdf>

ELEMENTUM eco. (2013). *Wall element – wall element with slotted steel studs and insulation of graphite EPS.* (Written in Swedish). PDF. Available: <http://www.elementumeco.se/laddahem/> [2016-03-08]

ELEMENTUM eco. (2016). *ELEMENTUM eco AB.* Available: <http://www.elementumeco.se/foretaget/> [2016-03-08]

Elitfönster (2016). *Price list.* (Written in Swedish). Available: http://www.elitfonster.se/Documents/Prislistor/Prisbok_2016.pdf [2016-04-25]

Energi & Miljö (2010). *From F to FTX in the million program.* (Written in Swedish). Available: <http://www.energi-miljo.se/tidningen/fran-f-till-ftx-i-miljonprogrammet> [2016-03-20]

Energimyndigheten (2016). *Status report of project: Nordic Built Active Roofs and Façades in Sustainable Renovation.* (Written in Swedish).

Equa (2016). *IDA Indoor climate and Energy.* Available: <http://www.equa.se/en/ida-ice> [2016-02-23]

E2B2 (2015). *Feasibility study of prefabricated multi-active facade elements for energy renovation of multi-family houses.* (Written in Swedish). PDF.

FEBY12 (2012) *Specifications for zero-energy buildings, passive and low-energy buildings* (Written in Swedish). PDF. Available: <http://www.nollhus.se/dokument/Kravspecifikation%20FEBY12%20-%20bostader%20sept.pdf> [2016-05-12]

Formas (2012). *The million program – renovate or demolish?* (Written in Swedish) PDF. Forskningsrådet Formas. Available: http://www.formas.se/PagesFiles/3678/miljonprogrammet_utveckla_eller_aveckla.pdf [2016-03-20]

Fraunhofer ISE (2016). *Research projects- Retrokit, Prefabricated multifunctional façades.* Available: <https://www.ise.fraunhofer.de/en/research-projects/retrokit-toolboxes> [2016-05-02]

Förvaltaren (2015). *Questions and answers*. Available:

<https://www.forvaltaren.se/artikel/fragor-och-svar-logdansvagen?mobileswitch=0>. [2016-05-05]

GAP³ Solutions I (2016). *Building and refurbishment with GAP³ Integral façade technology*. PDF.

GAP³ Solutions II (2016). *GAP³ Solutions - GAP:air* Available: <http://www.gap-solutions.at/en/solutions/gapair/> [2016-04-18]

GAP³ Solutions III (2016). *GAP:water – Technical documentation (Written in German)*. PDF.

Geier 2009. *Redevelopment residential area “Dieselweg”, Graz (Austria)*. AEE INTEC. Available: http://www.lehr.be/Downloads/10_Geier.pdf [2016-05-11]

GiwoG (n.d.). *Refurbishment into Passivhouse standard. Graz, Dieselweg*. Available: http://www.giwog.at/fileadmin/kundendaten/downloads/dieselweg_english.pdf [2016-05-11]

Heat2 (2014). *Heat2*. Available: <http://www.buildingphysics.com/index-filer/heat2.htm> [2016-04-25]

Hem & Hyra (2013). *Rent supplement after renovation*. (Written in Swedish). Available: <http://www.hemhyra.se/tips/sa-mycket-hojs-hyran-vid-renovering> [2016-05-05]

Hyresgästföreningen (2016). *Is there any limit for the rental supplement after a renovation*. (Written in Swedish). Available: (<http://www.hyresgastforeningen.se/stod-och-rad/fragor-och-svar/finns-det-en-grans-for-hur-mycket-hyran-kan-hojas-efter-en-renovering/>) [2016-05-05]

Höfler, K., Knotzer, A. & Venus, D. (2015). *Renovation concepts for net zero energy buildings – best practice residential building Kapfenberg/Austria*. *Advances in Building Energy Research*. 9:1, 107-119, DOI: [10.1080/17512549.2014.941007](https://doi.org/10.1080/17512549.2014.941007) Available: <http://dx.doi.org/10.1080/17512549.2014.941007> [2016-03-07]

Högdal, K. (2014). *Sealing of ventilation ducts - Pilot study for procurement of technology*. (Written in Swedish). PDF. Available: <http://www.bebostad.se/wp-content/uploads/2015/01/2013-31-Foerstudie-Kanaltaetning.pdf> [2016-04-22].

IEA EBC Annex 56 (2014). *Case study – Kapfenberg*. Available: <http://iea-annex56.org/index.aspx?MenuID=4> [2016-05-11]

IVA (2012). *Energy efficient renovation of multi-family houses in Sweden – Obstacles and opportunities while reducing the energy use by half by 2050*. (Written in Swedish) PDF. Kungl. Ingenjörsvetenskapsakademien. Available: <http://iva.se/globalassets/rapporter/ett-energieffektivt-samhalle/201206-iva-energieffektivisering-rapport1-f1.pdf> [2016-03-16]

Johab uterumsspecilisten (2016). *Price for glazing balconies*. Available: <http://uterumprisinglasning.johab.se/index.asp?sys=5> [2016-04-25]

Karlsson, C., & Levin, P. (2015). *Reliable Renovation. Pilot project for energy-efficient renovation of existing multi-family buildings. Final report for Lagersberg stage 2 – Kommunfastigheter in Eskilstuna*. PDF. [2016-05-22]

Karlsson, E. (2015). *Sustainable renovation in Malmö*. pp. 28-29. Association of Sustainable Cities and Buildings. 18. Aarhus 2015.

Lacave Azpeitia, I., Rodriguez Pando, A., Donkervoort, R. & Dijkmans, T. (2015). *AMANAC Session: how to design an adaptive wall panel for retrofitting with multiple innovative technologies All components integrated to the element are attached to the lightweight concrete*. Available: <http://www.adaptiwall.eu/downloads/#.VqXeuT2bIU> [2016-03-10]

LandskronaEnergi (2016) *Price terms for business activities in Landskrona*. (Written in Swedish). Available: <http://www.landskronaenergi.se/wp-content/uploads/2011/11/Prisvillkor-Näringsidkare.pdf> [2016-04-21]

Landskronahem AB (2015). *Annual report*. (Written in Swedish). PDF. <http://www.landskronahem.se/wp-content/uploads/Lahem-Arsredov2015-slutgiltig-lag.pdf> [2016-04-19]

Lundgren B. (2011). *World sustainable energy days*. Arkus Rapport #1/2012. (Written in Swedish). PDF. Available: <http://www.arkus.se/publikationer-for-nedladdning/world-sustainable-energy-days-wsed/> [2016-03-20]

Martinsson, L. (2014). *Evaluation of prefabricated wall – Solution for additional insulation for renovation of multi-family house*. (Written in Swedish). PDF. BeBo. Available: <http://www.bebostad.se/wp-content/uploads/2014/08/Utv%C3%A4rdering-av-prefabricerad-v%C3%A4gg-slutrapport.pdf> [2016-03-09]

MeeFS I (2016). *Retrofitting façade concept*. Available: <http://www.meefs-retrofitting.eu/project/retrofitting-façade-concept.html> [2016-01-22]

MeeFS II (2016). *Products under development*. Available: <http://www.meefs-retrofitting.eu/project/products-under-development.html> [2016-01-22]

Mjörnell, K. & Blomsterberg, Å. (2014). *Rational insulation of exterior walls and façades of existing multi-family buildings - Final report of development project*. TURIK 2. (Written in Swedish) PDF. Available: <http://www.bebostad.se/wp-content/uploads/2014/11/Slutrapport-TURIK-2-2014-08-14-final.pdf> [2016-03-09]

Mjörnell, K. & Werner, G. (2010). *Efficient insulation of the building envelope of existing multi-family buildings - Pilot study for procurement of technology*. BeBo. (Written in Swedish). Available: <http://www.bebostad.se/wp-content/uploads/2014/09/Rapport-foerstudie.TURIK-2010-11-04.pdf> [2016-03-14]

My News Desk (2014). *Einar Mattsson bygg AB wins price for innovative sustainability efforts*. (Written in Swedish). Available: <http://www.mynewsdesk.com/se/einar-mattsson-ab/pressreleases/einar-mattsson-prisas-foer-innovativt-haallbarhetsarbete-1082194> [2016-04-07]

Nord Pool (2016). *Elspot prices*. Available: <http://www.nordpoolspot.com/Market-data1/Elspot/Area-Prices/SE/Yearly/?view=table> [2016-04-19]

Nordic Built (2014). *Active roofs and façades in Sustainable renovation*. Available: <http://www.nordicinnovation.org/nordicbuilt/funding-opportunities/funded-projects-through-nordic-built-in-2013/nordic-built-active-roofs-and-façades-in-sustainable-renovation/> [2016-03-24]

Ott, S, Loebus, S, Time, B, Homb, A & Botsch, R. (2014). *SmartTES - Book 3, Multifunctional TES*. PDF. Available: http://www.smarttes.com/downloads/smarttes_b3_Multifunctional [2016-03-20]

Paroc Group I (2016). *Façades with thick rendering*. (Written in Swedish). Available: <http://www.paroc.se/losningar-och-produkter/losningar/vaggar/putsade-fasader-tjockputs> [2016-05-10]

Paroc Group II (2016). *Innovative energy renovation nominated to the "Building of the year" 2016*. (Written in Swedish). Available: <http://www.paroc.se/om-paroc/nyheter-och-media/nyhetsarkiv/2016/innovativ-energirenovering-nomineras-till-arets-bygge-2016-> [2016-04-06]

SAPA Building System (2012). *Sapa Solar*. PDF. Available: http://www.sapagroup.com/companies/Sapa%20Building%20System%20AB/Pictures/brochures/Sapa_Solar_2012_SE_low.pdf [2016-05-10]

SCB (2015). *Energy prices and switching of suppliers, 4rd quarter 2015*. ISSN: 1404-5869. (Written in Swedish). Available: http://www.scb.se/Statistik/EN/EN0304/2015K04/EN0304_2015K04_SM_EN24SM1601.pdf [2016-04-19]

SCB (2016). *Calculated housing stock*. (Written in Swedish). Available: <http://www.scb.se/sv/Hitta-statistik/Statistik-efter-amne/Boende-byggande-och-bebyggelse/Bostadsbyggande-och-ombyggnad/Bostadsbestand/87469/87476/Behallare-for-Press/Kalkylerat-bostadsbestand-2012/> [2016-03-09]

Smartfront (2015). *System description*. (Written in Swedish). PDF. Available: http://media.smartfront.se/2015/10/Systembeskrivning_2015-10-30.pdf [2016-03-26]

Smartfront (2016). *How it works*. (Written in Swedish). Available: <http://smartfront.se/> [2016-03-21]

Social Board (2005). *Indoor temperature*. Available:
<https://www.folkhalsomyndigheten.se/pagefiles/12940/temperatur-inomhus.pdf> [2016-04-25]

SP fönster (2016). *Price list 6:0*. (Written in Swedish). Available:
http://www.bygglagret.se/UserFiles/SP/sp_prislista_160314_FINAL_LOW.compressed.pdf [2016-04-25]

SVEBY (2012). *Users input data for residences*. (Written in Swedish). PDF. Available:
http://www.sveby.org/wp-content/uploads/2012/10/Sveby_Brukarindata_bostader_version_1.0.pdf [2016-02-23].

Sveriges Riksbank (2016). *Current inflation rate*. Available:
<http://www.riksbank.se/sv/Penningpolitik/Inflation/Inflationen-just-nu/> [2016-04-19]

Swedish Public Health Agency (2016) *Indoor temperature* (Written in Swedish). Available:
<https://www.folkhalsomyndigheten.se/amnesomraden/halsoskydd-och-miljohalsa/inomhusmiljo/temperatur/> [2016-05-16]

Swedisol (2016). *The million program – renovate or demolish?* (Written in Swedish). Available: <http://www.swedisol.se/energipolitik-energieffektivisering-klimat-energim%C3%A5l> [2016-03-09]

TES EnergyFaçade (2009). *TES EnergyFaçade manual*. Final project report. PDF. Available: http://tesenergyfaçade.com/downloads/TES_Manual-ebookFINAL.pdf [2016-03-20]

TES EnergyFaçade (2016). *TES EnergyFaçade*. Available:
http://www.tesenergyfaçade.com/index.php?id=13_tes [2016-03-20]

Treberspurg, M. & Djalili, M. (2010). *New technical solutions for energy efficient buildings, State of the art report - Multifunctional façade systems*. PDF. Sci-Network. Available:
http://www.sci-network.eu/fileadmin/templates/sci-network/files/Resource_Centre/Innovative_Technologies/State_of_the_Art_Report_Multifunctional_Façade_Systems.pdf [2016-03-09]

VIP-Energy (2016). *VIP-Energy*. (Written in Swedish). Available:
<http://www.vipenergy.net/index.htm> [2016-05-21]

VVS Företagen (2009). *Renovation manual for buildings built 1950-75*. (Written in Swedish). Wallén Grafiska AB, Stockholm. ISBN: 978-91-976619-3-5.

Warfvinge, C. & Dahlblom, M. (2012). *Planning of HVAC-installations*. (Written in Swedish). ISBN: 978-91-44-05561-9

Wikells byggberäkningar AB (2016). *About the company*. (Written in Swedish). Available:
<http://www.wikells.se/omwikells.aspx> [2016-04-25]



LUND UNIVERSITY

Dept of Architecture and Built Environment: Division of Energy and Building Design
Dept of Building and Environmental Technology: Divisions of Building Physics and Building Services